

**Gaber**<sup>®</sup>  
gaber.it



**ACOUSTIC COLLECTION**



Gaber® Acoustic Collection

# Contents



INTRO 04

ONDA LAMP 62



DIAMANTE 44



STILLY 22



FONO 28



PIUMA 58



UNIKO 36



MADISON 40

# Milestones

CONTRACT MADE IN ITALY

[IT] Gaber® progetta, sviluppa e produce i propri prodotti in Italia. Nei prodotti si ritrovano la fantasia, la dinamicità e la flessibilità tipiche dello spirito italiano. Le radici nella tradizione del **Made in Italy** e lo sguardo proiettato sul mondo hanno portato Gaber a fornire competenza, **tecnologie innovative** e customizzazione al servizio del mondo dell'architettura e del design.

[EN] Gaber® designs, develops and manufactures in Italy. In our products you can find imagination, dynamism and flexibility, typical of the Italian spirit. Traditional **Made in Italy** rules of design, and a constant view of the world of furniture have led Gaber furniture to be included in prestigious contract projects. Expertise, **innovative technology** and customization all serving the world of architecture and design: these are the main aspects of the Gaber contract division.

[FR] Gaber® projette, développe et fabrique ses produits en Italie. Au sein de sa gamme, on dénote de la fantaisie, du dynamisme et la flexibilité typique du gout italien. Le **Made in Italy** a ses racines dans la tradition à travers laquelle Gaber a pu démontrer ses compétences, sa **technologie et son innovation** au service du monde de l'architecture et du design.

[SP] Gaber® diseña, desarrolla y fabrica sus productos en Italia. En los productos se encuentran la imaginación, el dinamismo y la flexibilidad típica del espíritu italiano. Las raíces en la tradición del **Made in Italy** y la visión global permiten a Gaber ofrecer conocimiento, **tecnología innovadora** y personalización para el mundo de la arquitectura y el diseño.



## AWARDS

[IT] Gaber ha ottenuto importanti riconoscimenti a livello internazionale, grazie alle innovazioni tecnologiche, al design e all'originalità dei propri prodotti.

[EN] Gaber has won multiple international design awards. These recognitions are a testament to Gaber's unstinting commitment to design and innovation.

[FR] Gaber a reçu de nombreux prix au niveau international, grâce à l'innovation technologique, au design et à l'originalité de ses produits.

[SP] Gaber ha sido ampliamente reconocida a nivel internacional, gracias a las innovaciones tecnológicas, diseño y originalidad de sus productos.

## PATENTS

[IT] Le collezioni Gaber racchiudono molteplici brevetti, tecnici ed ornamentali, che derivano da una costante fase di ricerca e sviluppo, anche in collaborazione con università ed istituti di ricerca.

[EN] The Gaber collections contain multiple patents, both technical and design, which stem from constant research and development, even in partnership with universities and research institutes.

[FR] Les collections Gaber détiennent des brevets de fabrication, que ce soit au niveau technique mais aussi décoratif; ces brevets sont le fruit d'une recherche et d'un développement constant, en collaboration avec les instituts de recherche universitaires.

[SP] Las colecciones Gaber contienen múltiples patentes, técnicas y decorativas, resultado de una fase constante de investigación en colaboración con universidades e institutos de investigación.



[IT] Gaber® nasce dalla fusione dell'esperienza sviluppata in diverse attività di ideazione, progettazione, costruzione e produzione di particolari in materiale plastico, dedicandosi alla realizzazione di complementi d'arredo dallo stile sempre originale e di grande qualità. Il prodotto Gaber è un oggetto innovativo. Grazie alla capacità di utilizzo delle tecnologie più avanzate del settore, l'azienda si presenta con una veste fresca ed elegante capace di anticipare le richieste del mercato. I prodotti vengono seguiti con cura e passione dalla nascita, alla progettazione, alla creazione delle attrezzature, alla fusione del pezzo, fino alla distribuzione.

[EN] Gaber® was born from the fusion of different design experiences, the construction and production of plastic components with dedication to the realization of furnishings from high quality and original style every time. Gaber products always smack of innovation. Years of experience in the design of plastic products, manufacturing moulds and tools, metalworking, and moulding, have brought us today to be able to meet and anticipate market trends. Great creative capabilities, consolidated expertise and flexibility allow us to offer products that stand out in terms of design and quality.

[FR] Gaber® nait de la fusion et de l'expérience en diverses activités: étude, réalisation de moules et enfin production de pièces en matière plastique, tout en s'orientant vers la réalisation d'articles pour l'aménagement, d'un style souvent originale et de grande qualité. Le produit Gaber est un objet d'innovation. Gaber, grâce à sa capacité et à l'utilisation de technologies performantes, mêle style et élégance qui permet à l'usine d'anticiper les tendances et les demandes du marché. Le produit Gaber est suivi avec soin, de sa naissance, au projet, en passant par la création des outils nécessaires à sa réalisation et jusqu'à la distribution sur le marché.

[SP] Gaber® nace de la fusión de la experiencia desarrollada en el proceso de creacion, diseño, construcción y producción de componentes de plastico, dedicándose a la realización de muebles de estilo original y de alta calidad. El producto Gaber es siempre un objeto de innovación. Gracias a la capacidad de utilizar las tecnologías más avanzadas en la industria, la empresa siempre refleja una imagen fresca y elegante capaz de anticipar las demandas del mercado. Además, los productos son tratados con cuidado y pasión desde su conceptualización, diseño, creación de la maquinaria, fusión de la pieza, hasta la distribución.



# Function Design and Sustainability



## GREEN DESIGN

[IT] La sostenibilità dei sistemi acustici Gaber è accentuata dalla riciclabilità, garantita dalla scelta del materiale per il telaio di supporto e dalla facilità di manutenzione delle coperture: entrambi i materiali sono riciclabili al 100%. I sistemi fonoassorbenti utilizzano un telaio realizzato in tecnopolimero antiurto e antistatico. Il feltro modellato in poliestere a media densità è il materiale base, rivestito con tessuto di poliestere o di lana/poliammide, disponibili in varie colorazioni. Il materiale è riciclabile, fonoassorbente, resistente al fuoco, leggero e durevole.

[EN] The sustainability of Gaber acoustic systems is accentuated by recyclability, assured through the choice of the support-frame material and the easy maintenance of the various cover systems: both materials are 100% recyclable. Gaber Acoustic Systems use a support-frame made of shock-resistant and anti-static technopolymer. Moulded medium-density polyester felt is the basic material, coated with a coloured polyester or wool/polyamide fabric. The material is recyclable, sound absorbent, fire resistant, lightweight and durable.

[FR] Le développement durable des systèmes acoustiques Gaber met l'accent sur le recyclage, sur le choix des matériaux utilisés pour le support, la facilité d'entretien du revêtement: tout est recyclable à 100%. La feutrine modelée en polyester de moyenne densité représente la base, cette feutrine est ensuite recouverte de tissu en polyester ou laine/polyamide, le tout disponible dans de nombreuses tonalités. Le matériel est recyclable, phono absorbant, non feu, léger et durable.

[SP] La sostenibilidad de los sistemas acústicos de Gaber se ve acentuada por el reciclaje, garantizada por la elección del material para la estructura de soporte y la facilidad de mantenimiento del revestimiento: ambos materiales son 100% reciclables. El feltro moldeado de densidad media de poliéster es el material base, cubierto con tela de poliéster o lana/poliamida disponible en varios colores. El material es reciclable, absorbe el sonido, resistente al fuego, ligero y duradero.



## DESIGNER

[IT] Forme, colori, grafiche e materiali dei sistemi acustici Gaber prendono forma in collaborazione con i più importanti designers, per arrivare alla piena soddisfazione delle esigenze progettuali, sia tecniche che decorative.

[EN] Shapes, colours, graphics and materials for Gaber acoustic systems are conceived in partnership with leading designers, in order to ensure total satisfaction, both technical and decorative, on project requirements.

[FR] Les formes, les couleurs, le graphisme et les matériaux des systèmes acoustiques Gaber ont pris forme grâce à la collaboration avec d'importants designers, ce qui a permis d'adapter les produits aux demandes les plus exigeantes au niveau technique mais aussi décoratif.

[SP] Formas, colores, gráficos y materiales de los sistemas acústicos de Gaber se concretan en colaboración con los diseñadores más importantes, para llegar a la plena satisfacción de los requisitos del proyecto, tanto técnicos como decorativos.

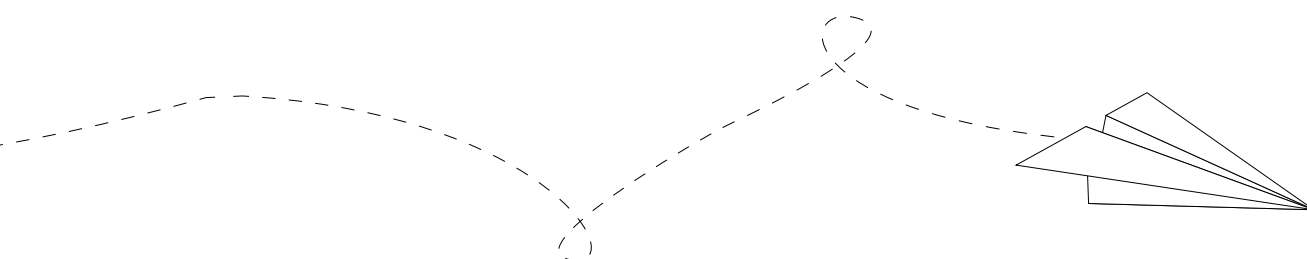

# Acoustic Architecture



[IT] I pannelli fonoassorbenti hanno la funzione di **limitare il riverbero**, all'interno degli ambienti confinati. Negli ambienti chiusi, il rumore complessivo percepito è maggiore della reale sorgente che lo ha generato poiché è incrementato dalle riflessioni prodotte dalle pareti, soprattutto se queste sono costituite da materiali lisci e compatti (riflettenti). La funzione dei pannelli fonoassorbenti è quindi quella di trasformare le superfici riflettenti in **superfici acusticamente assorbenti**.

Il programma acustico brevettato di Gaber è stato sviluppato con l'obiettivo di coniugare il miglioramento ambientale acustico con l'estetica di disegni artistici. Progettato per alleviare l'eccessivo riverbero, il programma si compone di pannelli a parete, pannelli a soffitto e lampade. Il risultato finale è una gamma di prodotti che elevano esponenzialmente il **benessere acustico** di ogni ambiente, ma che migliorano anche l'esperienza visiva.

[EN] Acoustic panels are designed to **limit reverberation** within confined environments. In enclosed spaces, the overall noise is greater than the source that generated it, increased from the reflections produced from walls, especially if these are made of smooth and compact materials (reflective). The function of the sound absorbing panels is therefore to transform the reflective surfaces in **acoustically absorbent surfaces**.

Gaber patented acoustic program was developed with the aim of combining acoustic improvement with the aesthetic of artistic designs. Designed to relieve excessive reverberation, the program consists of wall panels, ceiling panels and lamps. The final result is a range of products that **reduce noise**, but also enhances the visual experience.

[FR] Les panneaux insonorisants ont pour fonction de **limiter la réverbération** à l'intérieur des lieux confinés. Dans les espaces fermés, le bruit perçu est supérieur à la source réelle qui l'a généré puisqu'il est amplifié par les réflexions produites par les murs et plafonds, surtout si ceux-ci sont fait d'un matériel lisse e compact (réfléchissant). La fonction des panneaux insonorisants est donc de transformer les surfaces réfléchissantes en **surfaces absorbantes acoustiquement**.

Le programme acoustique breveté Gaber a été développé dans le but d'allier **une meilleure acoustique** à l'esthétique du design. Ce programme projeté pour diminuer l'écho, se compose de panneaux muraux, de panneaux pour le plafond et de lampes: une gamme complète pour réduire le bruit, tout en restant un plaisir pour les yeux.

[SP] Los paneles acústicos están diseñados para **limitar la reverberación** dentro de ambientes confinados. En espacios cerrados, el ruido total percibido es mayor que la fuente real que las generó, con un incremento de las reflexiones producidas por las paredes y el techo, especialmente si estos están hechos de material liso y compacto (reflectante). Por lo tanto, la función de los paneles que absorben el sonido es transformar las superficies reflectantes en **superficies acústicamente absorbentes**.

El programa acústico patentado de Gaber ha sido desarrollado con el objetivo de combinar la **mejora del medio ambiente** con la estética acústica de diseño artístico. Diseñado para aliviar la reverberación excesiva, el programa se compone de paneles de pared, paneles de techo y lámparas. El resultado final es una gama de productos que además de reducir el ruido, mejoran la **experiencia visual**.



## MORE THAN GOOD ACOUSTIC

[IT] Gli spazi indisturbati sono sempre più una necessità. Nell'ambiente di lavoro come in quello domestico, vivere in un habitat acusticamente sano migliora la qualità del nostro tempo in modo sorprendente.

La progettazione acustica aumenta la produttività, favorisce una sensazione di benessere e aiuta il recupero dallo stress quotidiano.

[EN] Peace and quiet have become scarce commodities. The need for undisturbed spaces is greater than ever: suitable interior acoustics improve everyone's productivity, well-being and good health.

The goal is to help create a sustainable sound environment for more efficient work output and better breakout areas.

[FR] Les espaces de repos deviennent de plus en plus une nécessité. Au travail comme chez soi, vivre dans un environnement acoustiquement sain, améliore la qualité de vie de façon surprenante.

Le design acoustique augmente la productivité, en favorisant une sensation de bien être tout en aidant la récupération liée au stress quotidien.

[SP] Espacios sin ruido son una necesidad. La convivencia en el lugar de trabajo y en el hogar en un hábitat acústicamente correcto mejora la calidad de nuestro tiempo.

Reducir el ruido acústico mejora la productividad, promueve una sensación de bienestar y ayuda a la recuperación del estrés diario.



# The Weight of Lightness

## LIGHTWEIGHT & STRONG

[IT] Leggerezza ed essenzialità consentono un semplice fissaggio a parete o a soffitto dei sistemi acustici Gaber, con l'ausilio di un **supporto brevettato nascosto**; i pannelli possono essere posizionati orizzontalmente, verticalmente o diagonalmente, offrendo agli utenti la possibilità di creare disegni simmetrici o asimmetrici. Le tecnologie e i materiali utilizzati rendono i prodotti **leggeri, maneggevoli, durevoli e resistenti** agli impatti, i prodotti possono arrivare ad un peso di 2,75kg per m<sup>2</sup>.

[EN] The lightness and simplicity of Gaber acoustic systems make for easy installation on walls and ceilings by using our **hidden patented bracket**, allowing the panels to be mounted either horizontally or vertically or even diagonally, offering users plenty of flexibility to create both symmetrical and asymmetrical patterns. The materials and technologies utilized result in **lightweight and easy to handle** products that are both **durable and impact-resistant**: the panels can reach a weight of 2,75kg per m<sup>2</sup>.

[FR] Légèreté et simplicité permettent une fixation facile sur les murs ou au plafond des systèmes acoustiques Gaber grâce à un **support caché et breveté**; les panneaux peuvent être placés horizontalement, verticalement ou en diagonale, offrant aux utilisateurs la possibilité de créer des dessins symétriques ou asymétriques. Les technologies et les matériaux utilisés en font des produits **légers, faciles à manipuler, durables et résistants** aux choc pouvant atteindre un poids de 2,75kg par m<sup>2</sup>.

[SP] Ligereza y simplicidad permiten una fácil fijación a la pared o en el techo de los sistemas acústicos Gaber, utilizando nuestro **apoyo oculto patentado**, que permite a los paneles ser colocados en posición horizontal, vertical o diagonal, dando a los usuarios la libertad de elección para crear dibujos simétricos o asimétricos. Las tecnologías y los materiales utilizados se convierten en productos **ligeros, fáciles de manejar y resistentes** a los golpes: los productos pueden alcanzar un peso de 2,75kg por m<sup>2</sup>.





## HIGH PERFORMANCE, LOW VOLUME

[IT] Tutta la superficie dei sistemi acustici Gaber è utile ai fini della correzione e del miglioramento del benessere acustico degli ambienti. Si tratta di prodotti realizzati con un sistema industriale, ai vertici della categoria che, grazie alle alte prestazioni, riduce al minimo l'impatto volumetrico per integrarsi perfettamente in tutti i progetti.

[EN] The entire surface of Gaber Acoustic systems is useful for correcting and improving the acoustic performance in various environments. These products are made through cutting edge industrial processes, as a result of which, extraneous sounds are minimized, making these systems fit perfectly into all projects.

[FR] Toute la surface des systèmes acoustiques Gaber est utile pour corriger et améliorer le bien-être acoustique des espaces. Il s'agit de produits réalisés avec un système industriel, au top de la catégorie qui, grâce à la haute performance, réduit au minimum l'impact volumétrique pour s'intégrer parfaitement dans tous les projets.

[SP] Toda la superficie de los sistemas acústicos Gaber es útil para corregir y mejorar el bienestar acústico de los ambientes. Estos productos están hechos con un sistema industrial, en la cima de la categoría que, gracias al alto rendimiento, se reduce a el mínimo impacto volumétrico, para integrar perfectamente en todos los proyectos.



# Quality and Performance







## ACOUSTIC COMFORT

[IT] I prodotti Gaber consentono un notevole miglioramento dell'acustica in case private, uffici, alberghi, ristoranti, ospedali, scuole, ambienti relax e spazi pubblici, decorando gli edifici più moderni ed intervenendo a posteriori su quelli esistenti eliminando il riverbero in modo rapido e semplice non modificandone la struttura.

[EN] Gaber acoustic products ensure significantly improved acoustics in private homes as well as in offices, hotels, restaurants, hospitals, schools, breakout areas and public spaces; decorating modern buildings and already existing installations, quickly and easily removing reverberation without structural modifications.

[FR] Les produits Gaber permettent une amélioration significative de l'acoustique dans les maisons, les bureaux, les hôtels, les restaurants, les hôpitaux, les écoles, les lieux de détente et les espaces publics tout en décorant les bâtiments les plus modernes et intervenant sur ceux existants en éliminant la réverbération rapidement et facilement sans changer la structure.

[SP] Los productos acústicos de Gaber permiten una mejora significativa de la acústica en los hogares, así como oficinas, hoteles, restaurantes, hospitales, escuelas, salas de relajación y espacios públicos; permiten la decoración de los edificios más modernos e intervenir con carácter retroactivo sobre los existentes, eliminando la reverberación fácil y rápidamente sin cambiar su estructura.

# Passion Takes Form

## MATERIALS

[IT] Rivestimenti e finiture superficiali suscitano emozioni e sollecitano i sensi: che si tratti di decori, texture o trame. Ricerca, sperimentazione e tecnologia aiutano Gaber nella produzione di nuovi **effetti tattili ed emozionali** per le superfici destinate all'Interior Design.

[EN] Coverings and finishes stimulate and impact on the senses: they are decoration, textures and patterns. Research, technology and development assist Gaber in the production of new **emotional tactile effects** on surfaces intended for Interior Design.

[FR] Les revêtements et finitions des surfaces arrivent à susciter en nous quelques émotions qu'il s'agisse du décor, des textures ou des motifs. La recherche, l'expérience et la technologie aident Gaber dans la production de nouveaux **effets tactiles et émotionnels** pour les zones Design de l'intérieur.

[SP] Revestimientos y acabados superficiales evocan emociones y sentidos: si se trata de decoraciones, texturas o diseños. La investigación, la experimentación y la tecnología ayudan Gaber en la producción de nuevos efectos táctil y emocionales para las áreas de los decoradores.



- 1 Tessuto di rivestimento / Fabric Coverings
- 2 Tessuto di rivestimento / Fabric Coverings
- 3 Tecnopolimero / Technopolymer



[IT] I prodotti assorbono effettivamente il rumore e i test dimostrano che i sistemi fonoassorbenti Gaber **migliorano significativamente** l'acustica. La superficie "perforata" dei rivestimenti consente alle onde sonore di penetrare nel centro del sistema (assorbimento); la sezione tridimensionale impedisce alle onde sonore di essere riflesse direttamente, evitando spiacevoli fenomeni di eco (diffusione).

[EN] These products effectively absorb sound and tests show that they also **significantly improve** acoustics. The "perforated" surface of the textile covers allows sound waves to travel into the core (absorption). The three-dimensional section of the acoustic panels prevents the sound waves from bouncing straight back, avoiding unpleasant echo (diffusion).

[FR] Cet article absorbe effectivement le bruit, les tests démontrent qu'il **améliore de façon significative** l'acoustique. La superficie "perforée" du revêtement permet aux ondes sonores de pénétrer à l'intérieur du panneau (absorption); la section 3D empêche aux ondes sonores d'être renvoyées directement, ce qui permet d'éviter le phénomène désagréable de l'écho (diffusion).

[SP] Los productos realmente absorben el ruido y las pruebas demuestran que los sistemas de absorción de Gaber **mejoran considerablemente** la acústica. La superficie de recubrimiento "perforada" permite que las ondas sonoras penetren en el centro de el sistema (absorción); la sección tridimensional de los paneles impide a las ondas sonoras que se reflejen directamente, evitando fenómenos de eco (difusión).

# A Quiet Revolution

[IT] I sistemi acustici Gaber sono stati testati in camera riverberante (semianecoica) secondo le norme UNI EN ISO 354 e UNI EN ISO 11654 per determinarne il coefficiente di assorbimento sonoro. I risultati dei test evidenziano le migliori capacità di miglioramento acustico in relazione al volume occupato, le misurazioni nelle diverse frequenze sono uno strumento indispensabile per i professionisti del settore.

[EN] Gaber acoustic systems have been tested in reverberation rooms (semi-anechoic) in accordance with UNI EN ISO 354 and UNI EN ISO 11654 standards, to determinate their sound absorption coefficient. Test results show the best acoustic improvement capacity in relation to the volume occupied, measurements at different frequencies are an indispensable tool for professionals.

[FR] Les systèmes acoustiques Gaber ont été testés en chambre réverbérante (semi-anéchoïque) selon la norme UNI EN ISO 354 et UNI EN ISO 11654 pour déterminer le coefficient d'absorption acoustique. Les résultats des tests montrent une excellente capacité d'amélioration acoustique par rapport au volume occupé, les mesures à différentes fréquences sont un outil indispensable pour les professionnels du secteur.

[SP] Los sistemas acústicos de Gaber se han probado en la cámara de reverberación (semianecoica) de conformidad con UNI EN ISO 354 y UNI EN ISO 11654 para determinar el coeficiente de absorción de sonido. Los resultados de las pruebas demuestran la mejor capacidad de mejora acústica en relación con el volumen que ocupa, las mediciones en diferentes frecuencias son una herramienta indispensable para los profesionales.

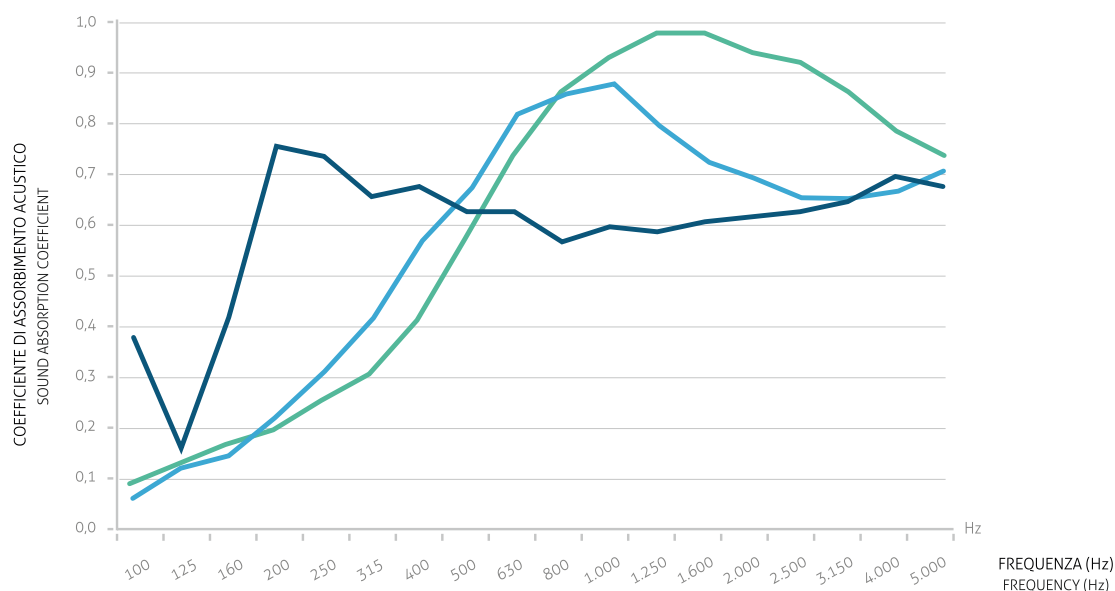

— STILLY / FONO  
Description tested sample:  
size 440mm x 440mm, max.  
height 40mm, mass 0.4kg.

— UNIKO / MADISON  
Description tested sample:  
size 600mm x 600mm,  
air gap 200mm, mass 0.6kg.

— DIAMANTE  
Description tested sample:  
size 1185mm x 595mm, max.  
height 33mm, mass 2.7kg.

## STILLY / FONO

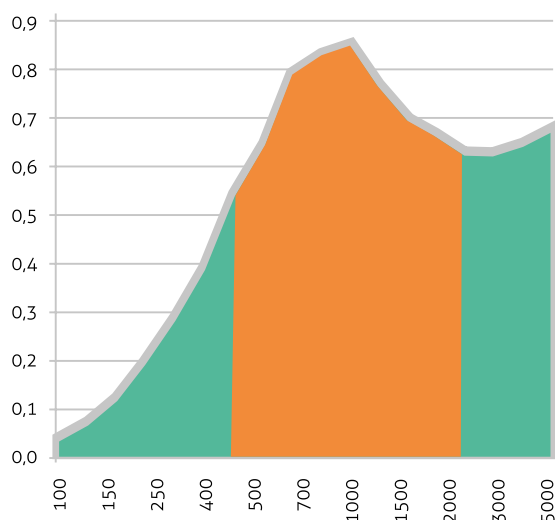

## UNIKO / MADISON

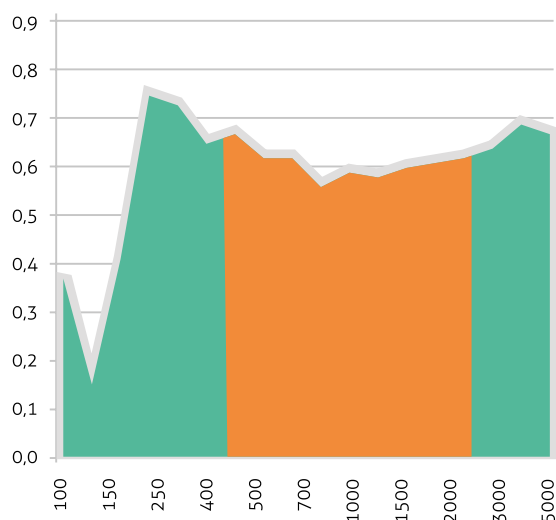

## DIAMANTE

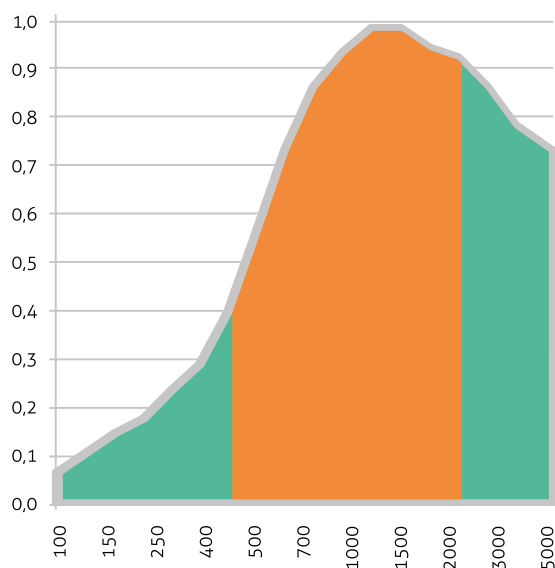

[IT] I grafici dimostrano come i pannelli acustici migliorino l'acustica di un ambiente: **assorbono efficacemente le medie frequenze**, tipiche della voce umana e dei rumori di fondo di tutti gli ambienti lavorativi (tra i 500 e i 2000 Hz).

[EN] Graphics show how acoustic panels improve acoustic environments: they **perfectly absorb the midrange frequencies** (between 500 to 2000Hz), those typical of the human voice and general noise in all workplaces.

[FR] Les graphiques montrent comment les panneaux acoustiques améliorent l'acoustique d'une pièce: ils **absorbent efficacement le milieu de gamme** (entre 500 et 2000 Hz), typique de la voix humaine et le bruit de fond.

[ES] Los gráficos muestran cómo los paneles acústicos mejoran la acústica de un lugar: **absorben con eficacia las frecuencias media** (de 500 a 2000Hz), típicas de la voz humana y de el ruido de fondo de los ambiente de trabajo.

## FIRE RESISTANCE

[IT] I materiali di rivestimento adempiono alle più importanti normative antincendio internazionali.

[EN] Covering polyester materials follows fire retardant international standards.

[FR] Les revêtements en tissu répondent aux normes internationales.

[ES] Los materiales de recubrimiento cumplen con las más importantes regulaciones internacionales contra el fuego.

# Enjoy the Silence

## MOUNTING

[IT] La posa risulta un'operazione molto rapida e, data la leggerezza dei prodotti, può essere eseguita da un solo operatore; l'estrema semplicità di fissaggio non richiede l'ausilio di personale esperto. I diversi sistemi di installazione accentuano la flessibilità dei prodotti e ne permettono l'impiego in ambienti pubblici e privati.

[EN] Thanks to the lightness of the products, installation is very quick and can be performed by one person and no specifically experienced fitters are necessary. The different installation systems show off the flexibility of the products and allow their use in public and private settings.

[FR] La pose est très rapide étant donné la légèreté des produits et peut être réalisée par un seul opérateur; l'extrême facilité de fixation ne nécessite pas l'aide d'un personnel expérimenté. Les systèmes d'installation divers accentuent la flexibilité des produits et permettent l'utilisation dans des environnements publics et privés.

[SP] La instalación es muy rápida y, dada la ligereza de los productos, se puede realizar por un solo operador; la extrema simplicidad no requiere la ayuda de personal con experiencia. Los diferentes sistemas de instalación acentúan la flexibilidad de los productos y permiten el uso en entornos públicos y privados.

## SERVICE

[IT] I sistemi acustici Gaber non richiedono manutenzione post-montaggio, l'assenza di spazi tra un pannello e l'altro riduce l'accumulo di polvere, la pulizia avviene per aspirazione negli elementi di tessuto e con un panno umido sui bordi in plastica.

[EN] Gaber acoustic systems do not require any particular maintenance, the lack of space between panels reduces dust build-up. All that is needed is simple vacuuming of the fabric parts and a normal cloth and warm water for polymer surfaces.

[FR] Les systèmes acoustiques Gaber ne nécessitent pas un entretien particulier. Le manque d'espaces entre un panneau et l'autre réduit l'accumulation de poussière, le nettoyage se fait par aspiration pour les éléments en tissu et avec un chiffon humide pour les bords en plastique.

[SP] Los sistemas acústicos de Gaber no requieren particular mantenimiento; la falta de espacios entre un panel y otro reduce la acumulación de polvo. La limpieza consiste en sistemas de aspiración en los elementos del tejido y un simple paño húmedo con agua tibia sobre las superficies de plástico.







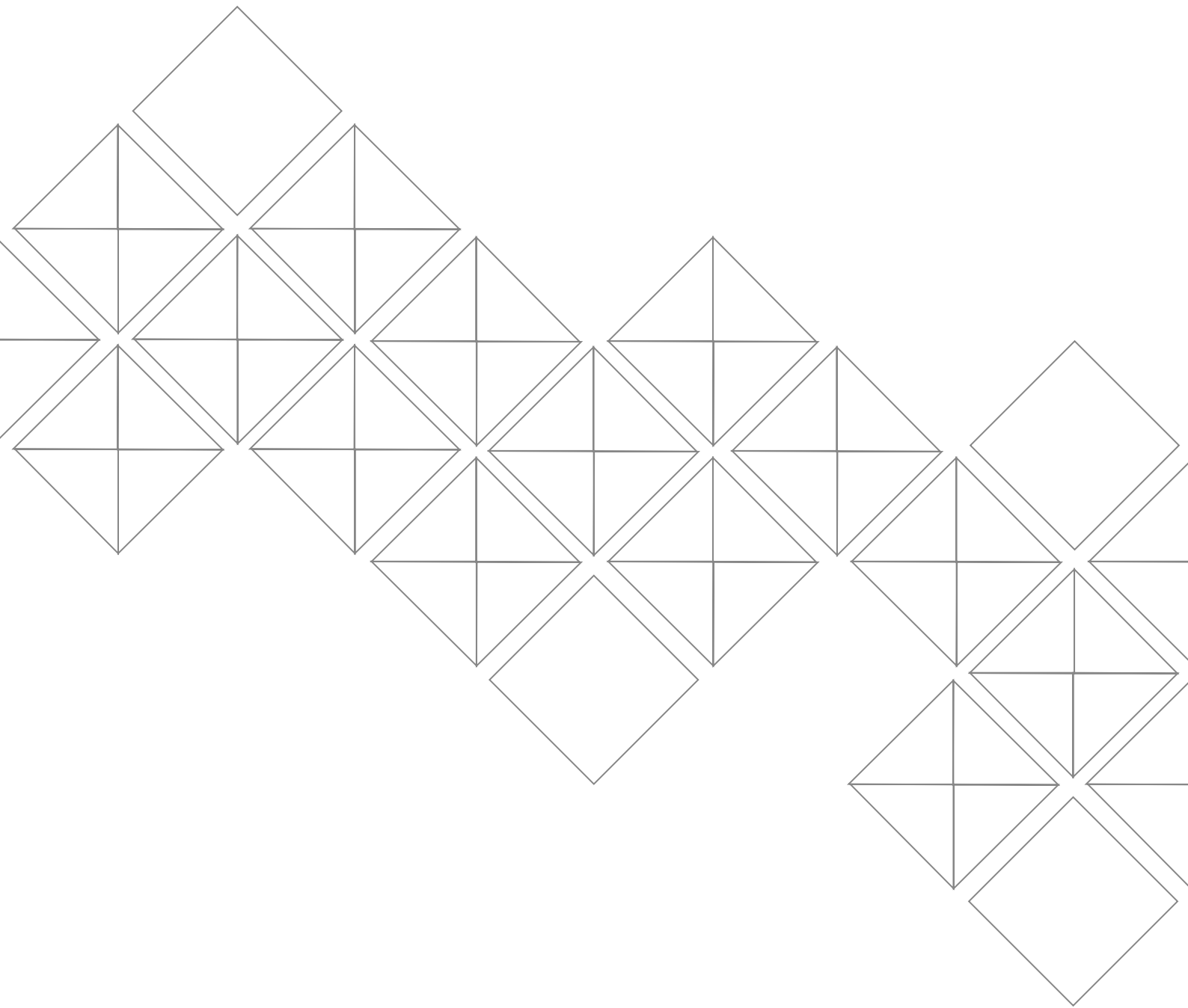

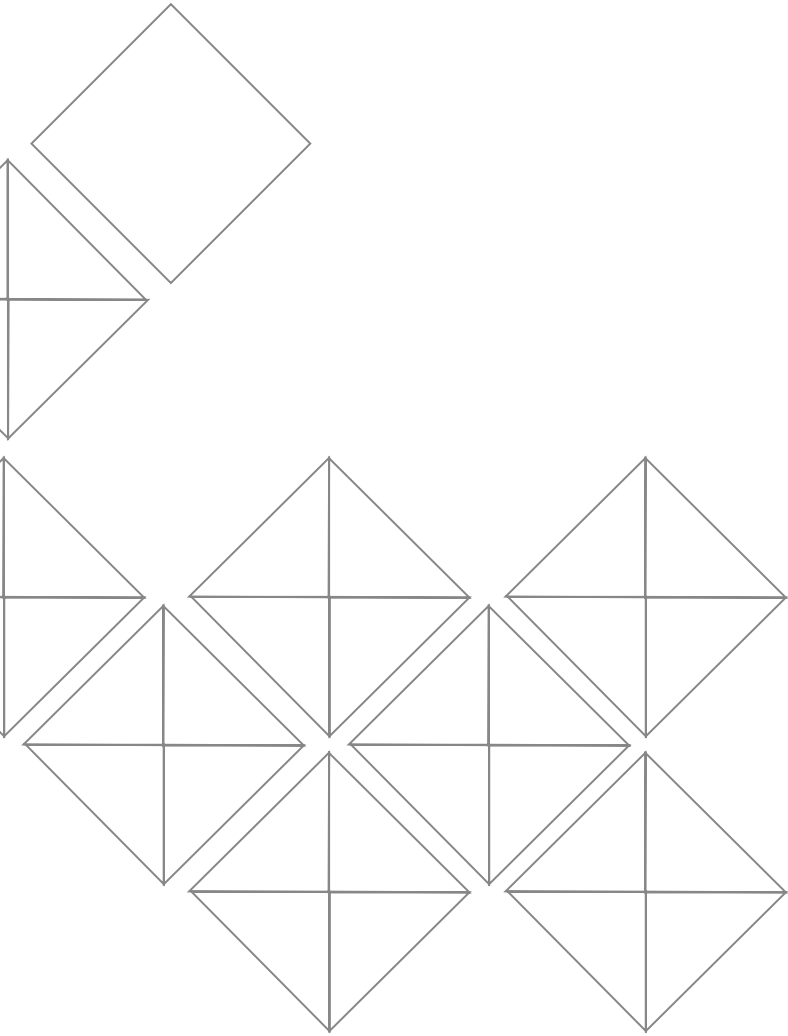

ACOUSTIC PRODUCTS





# Stilly

Studio Eurolinea Design

[IT] Il sistema di pannelli fonoassorbenti Stilly permette di realizzare un'ampia gamma di combinazioni, grazie alle versioni Flat o Pyramid, conferendo all'ambiente un tocco estetico di notevole pregio: il pannello fonoassorbente diventa un pezzo di **design contemporaneo**.

[EN] The Stilly sound-absorbing system allow, by combining the Flat and Pyramid versions, countless configurations, thereby adding a classy look to the surroundings. In this way, the sound-absorbing panels constitute **contemporary design** in themselves.

[FR] Le système de panneaux acoustic Stilly permet de réaliser une large gamme de combinaisons avec les versions Flat ou Pyramid, conférant une touche esthétique d'une grande valeur, le panneau insonorisant devient une pièce de **design contemporain**.

[SP] El sistema de paneles acústicos Stilly permite realizar una amplia gama de combinaciones, gracias a las versiones Flat o Pyramid, dando a el entorno un toque estético de gran valor: el panel fonoabsorbente se convierte en una pieza de **diseño contemporáneo**.

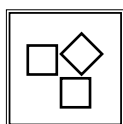

fissaggio a parete  
wall assembly

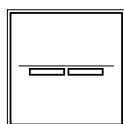

fissaggio a soffitto  
ceiling assembly



illuminazione opzionale  
lighting option



GOOD DESIGN AWARD 2014



# Technical Specifications

## SIZES

FLAT version  
FLAT BRILLIANT Led version

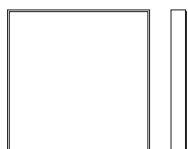

44x44x4 cm  
0.195m<sup>2</sup> - 0.4 kg

PIRAMID version  
PIRAMID BRILLIANT Led version

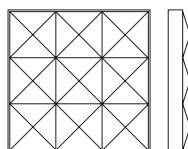

44x44x6 cm  
0.195m<sup>2</sup> - 0.4 kg



0.040 m<sup>3</sup> - 2.95 kg  
47x45x19 cm  
4pcs (carton)

Kit installazioni a soffitto / Ceiling installations Kit / Kit installations de plafond / Kit de instalación en el techo:  
ACCV002 - Staffe addizionali / Additional brackets / Supports supplémentaires / Soportes adicionales



<http://configurator.gaber.it/en/products/acoustic-system/stilly>



# FINISHING



Felt 700  
grigio/grey

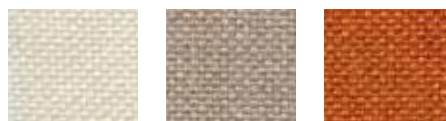

1012 avorio/ivory      1008 tortora/dove-grey      3082 arancio/orange

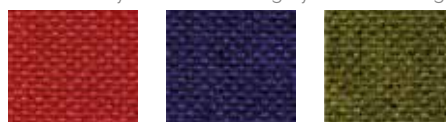

4021 rosso/red      6052 blu/blue      7022 verde/green

## Colors On Demand (minumum order 300pcs)

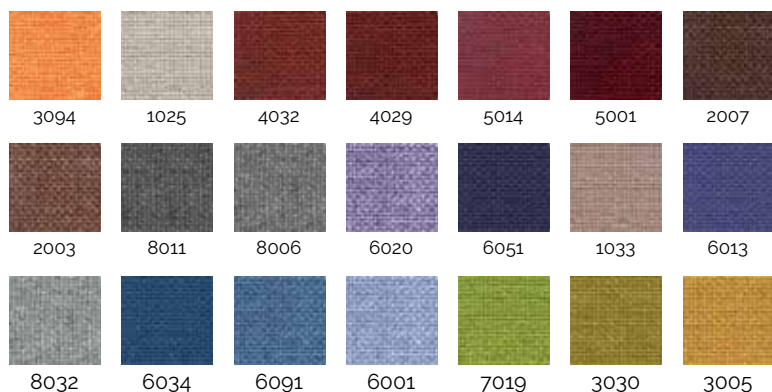

[IT] I materiali di rivestimento adempiono alle più importanti normative antincendio internazionali.  
 [EN] Covering polyester materials follows fire retardant international standards.  
 [FR] Les revêtements en tissu répondent aux normes internationales.  
 [ES] Los materiales de recubrimiento cumplen con las más importantes regulaciones internacionales contra el fuego.

UNI 9174 - 8456 Class C1, UNI 9175 Class 1 IM,  
 DIN 4102 Class B1, NF 92501-7 Class M1, NF D 60013 Class AM18, EN 1021-1 & 2, BS Crib 5, BS 7176 Class Medium Hazard, EN 13773 Class 1, OENORM 3800-1 Class B1.Q1.TR1, California TB117, USA NFPA 701, USA NFPA 260, IMO A 652 (16) Part 8 Upholstery

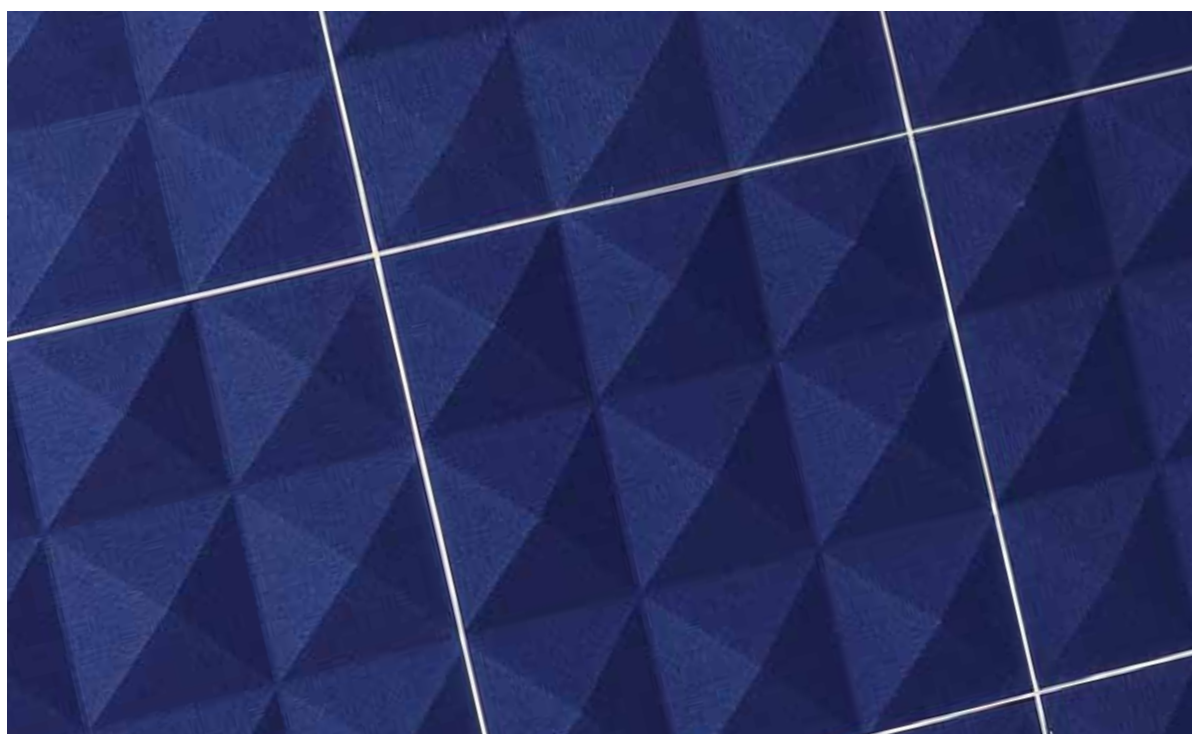

# Pattern Examples

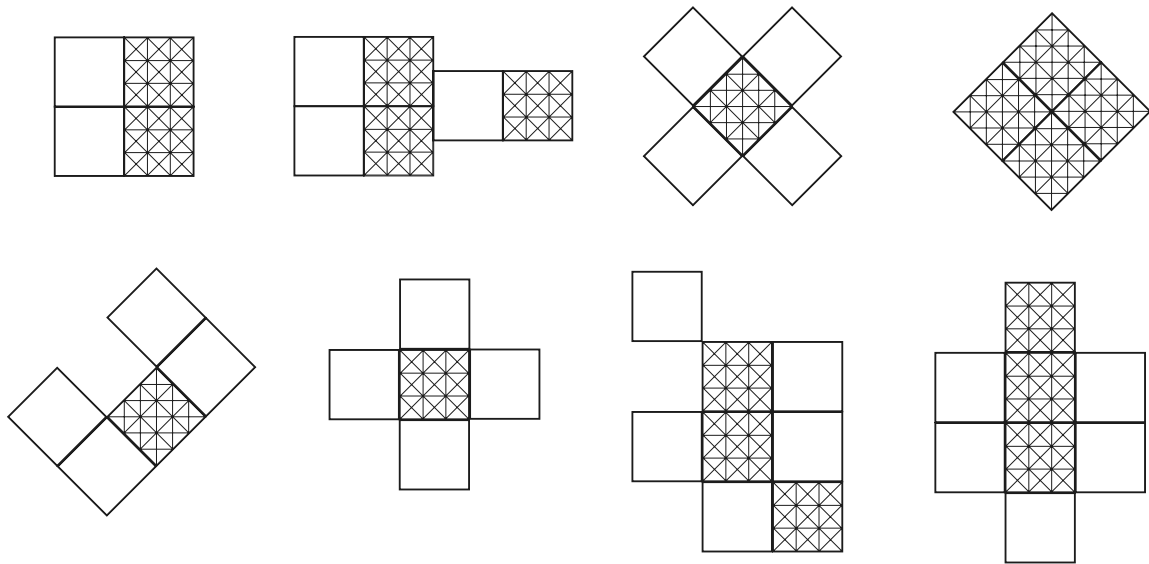

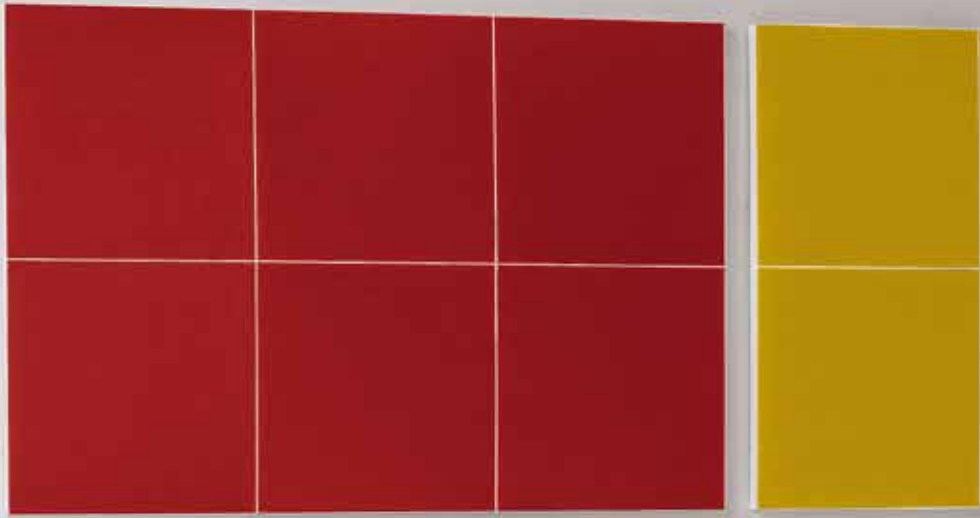

# Fono

Marc Sadler Design

[IT] "Fono" è un innovativo sistema acustico che re-interpreta il concetto di modularità e personalizzazione: i singoli pannelli si possono assemblare tra loro creando infinite composizioni decorative, offrendo quindi la massima libertà creativa.

[EN] "Fono" is an innovative acoustic system that re-interprets the concept of modularity and customization: the individual panels can be assembled together to create endless decorative compositions, thus providing maximum creative freedom.

[FR] "Fono" est un système acoustique innovant qui réinterprète le concept de la modularité et de la personnalisation: les panneaux individuels peuvent être assemblés ensemble créant des compositions décoratives infinies, offrant ainsi une liberté maximale de création.

[SP] "Fono" es un innovador sistema de absorción de sonido que reinterpreta el concepto de modularidad y personalización: los paneles individuales se pueden combinar juntos para crear una multitud de composiciones decorativas, proporcionando así la máxima libertad creativa.

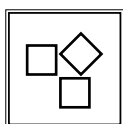

fissaggio a parete  
wall assembly

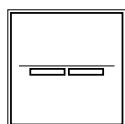

fissaggio a soffitto  
ceiling assembly



illuminazione opzionale  
lighting option



GOOD DESIGN AWARD 2014

OF CHICAGO ATHENAEUM MUSEUM OF ARCHITECTURE AND DESIGN



GERMAN DESIGN AWARD 2016

WINNER AWARDS





# Technical Specifications

## SIZES

A version

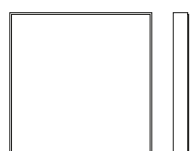

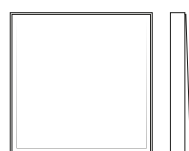

44x44x4 cm  
0.195m<sup>2</sup> - 0.55 kg

B/C/D version



44x44x6.2 cm  
0.195m<sup>2</sup> - 0.55 kg

Model A		0.040 m <sup>3</sup> - 2.95 kg 47x45x19 cm 4pcs (carton)
Model B		0.055 m <sup>3</sup> - 3.20 kg 47x45x26 cm 4pcs (carton)
Model C/D		0.047 m <sup>3</sup> - 3.10 kg 47x45x22 cm 4pcs (carton)

Kit installazioni a soffitto / Ceiling installations Kit / Kit installations de plafond / Kit de instalación en el techo:  
ACCV002 - Staffe addizionali / Additional brackets / Supports supplémentaires / Soportes adicionales

## CODES

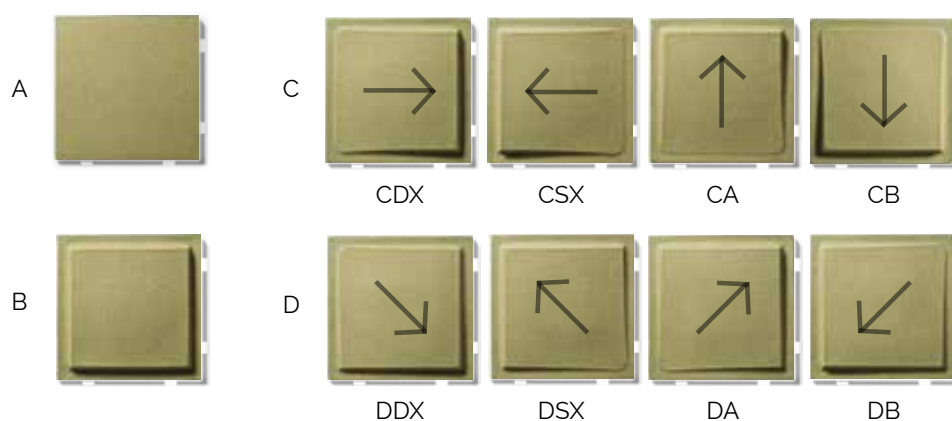

<http://configurator.gaber.it/en/products/acoustic-system/fono>



## FINISHING



505  
beige/beige



451  
verde/green



201  
rosso/red

### Colors On Demand (minumum order 300pcs)

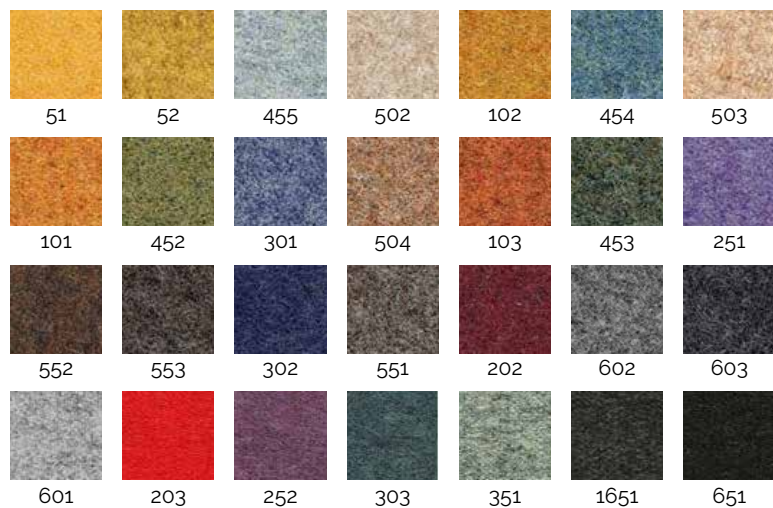

[IT] I materiali di rivestimento adempiono alle più importanti normative antincendio internazionali.  
 [EN] Covering polyester materials follows fire retardant international standards.  
 [FR] Les revêtements en tissu répondent aux normes internationales.  
 [ES] Los materiales de recubrimiento cumplen con las más importantes regulaciones internacionales contra el fuego.

UNI 9175:1987 + FA1:1994; UNI 9176:98 with appropriate PU foam;  
 UNI 8457:1987 - UNI 8457/A1:1996 Class 4;  
 UNI 9147:1987 - UNI 9147/A1:1996 Class 4;  
 BS EN 1021-1 Ign SOURCE 0 with appropriate PU foam;  
 BS EN 1021-2 Ign SOURCE 1 with appropriate PU foam;  
 CAL 117:JUNE 2013



# Pattern Examples

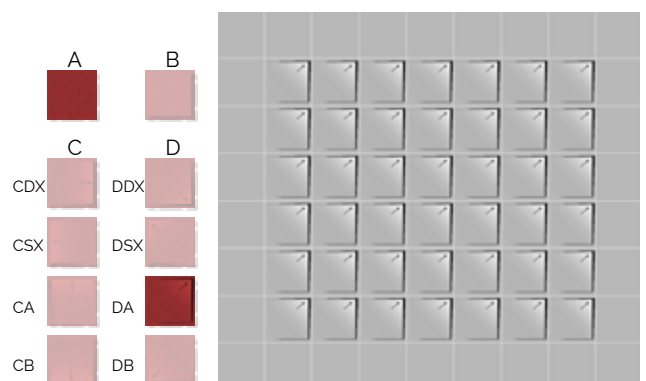
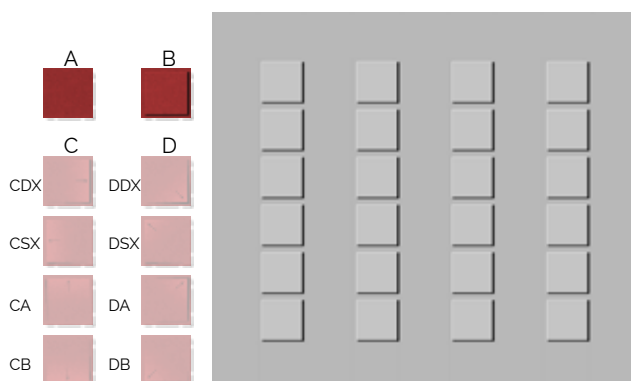
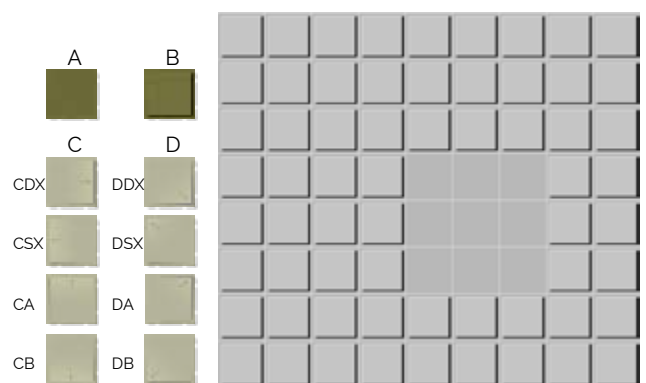
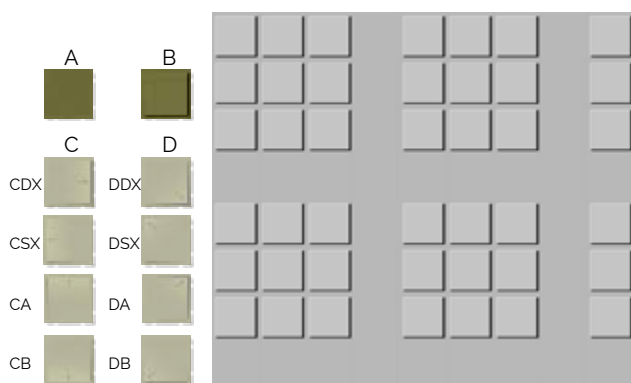
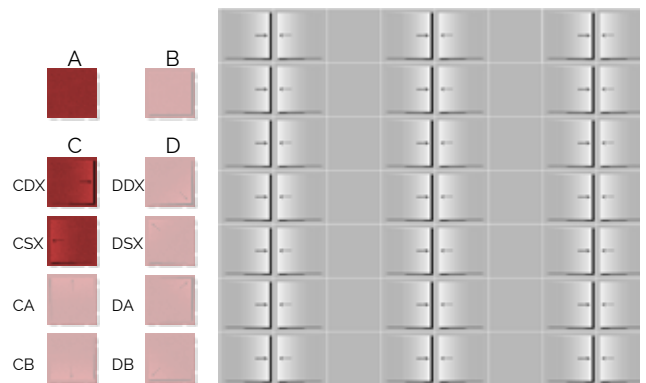
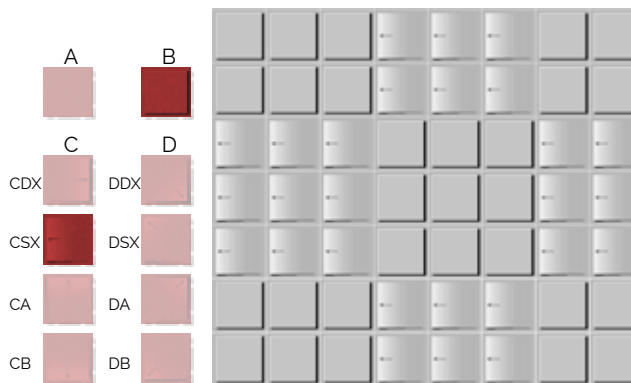



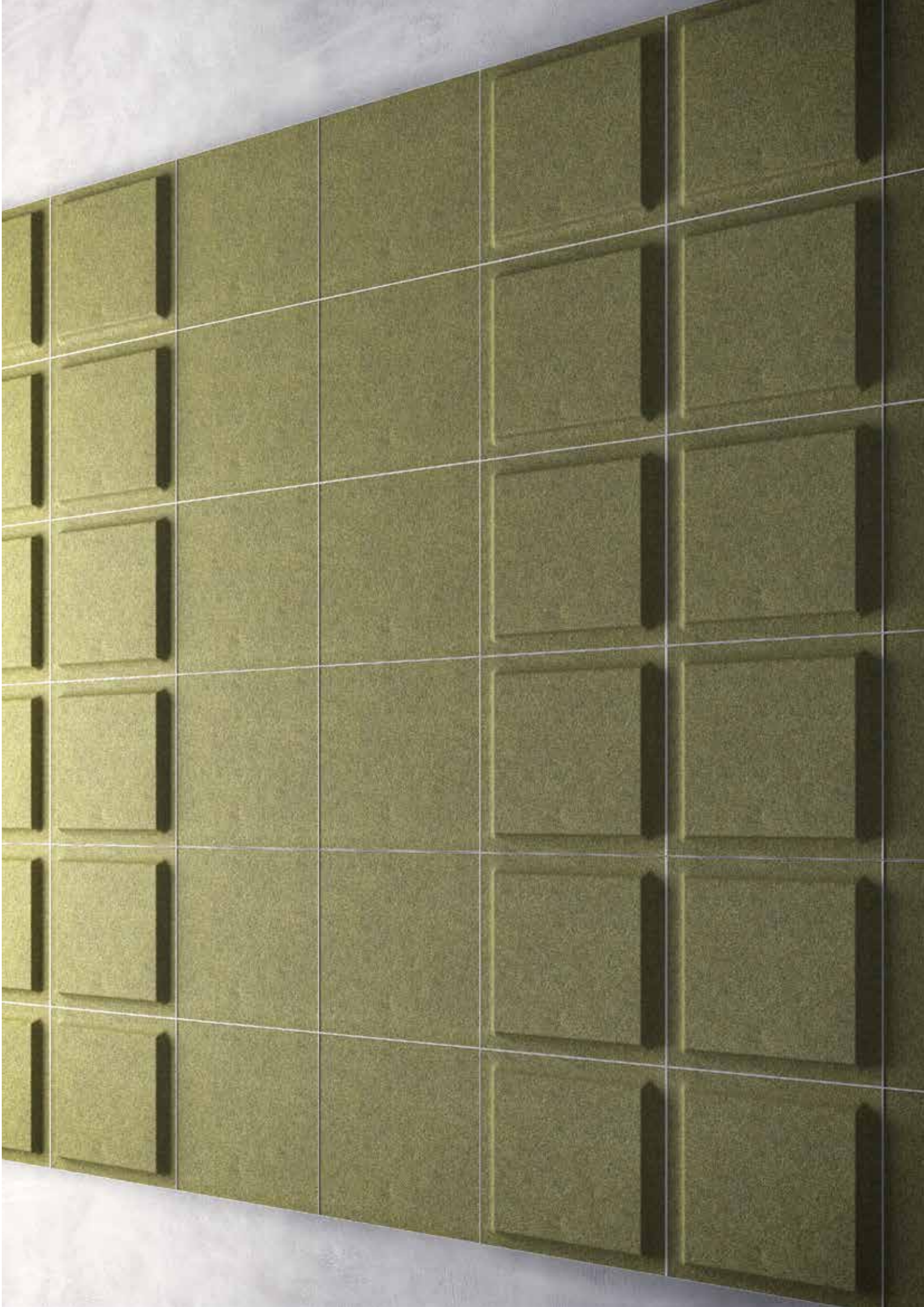





# Pattern Examples

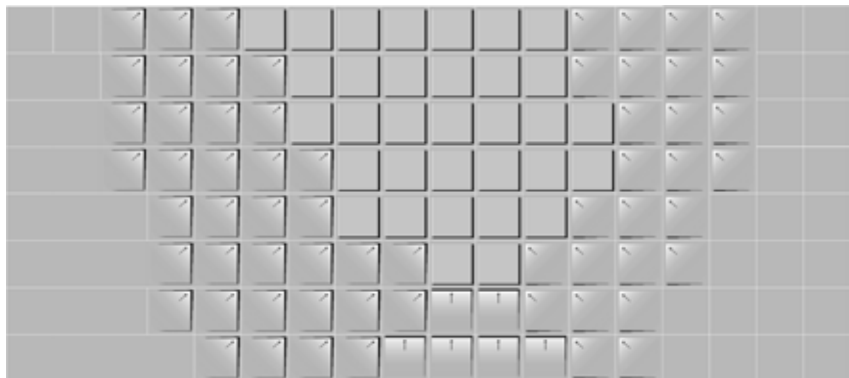
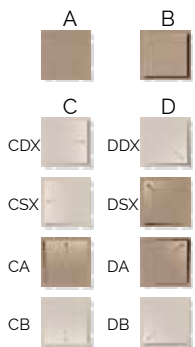
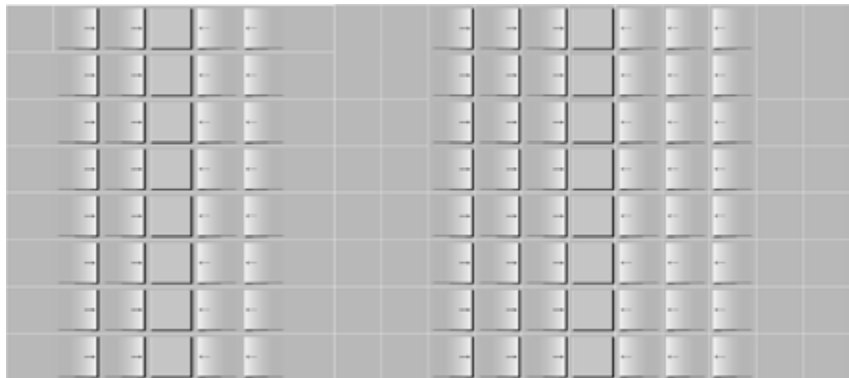
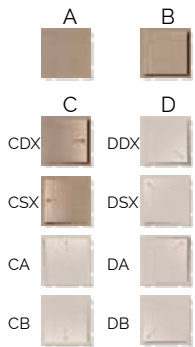
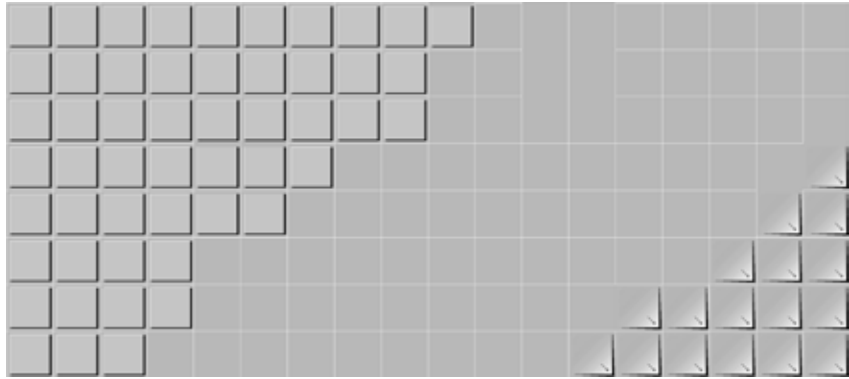
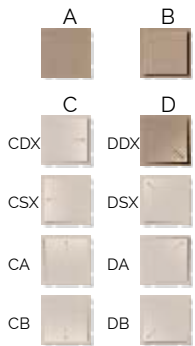
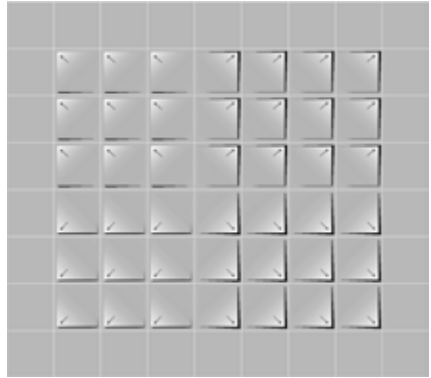
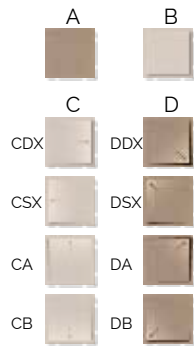
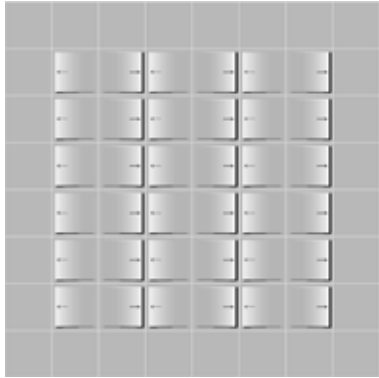
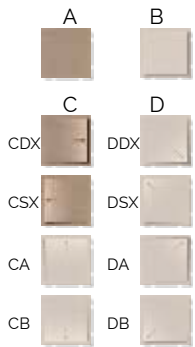





# Uniko

Studio Eurolinea Design

[IT] Uniko è un sistema a pannelli modulari per controsoffitti che unisce un elevato assorbimento acustico a un'estetica moderna ed elegante, in sintonia con le nuove tendenze dell'architettura e dell'interior design. La sua modularità e l'ampia gamma cromatica lo rende adatto a qualsiasi tipologia di ambiente migliorandone la vivibilità.

[EN] Uniko is a system of modular panels for false ceiling which combines great sound absorption with a modern and elegant pattern, in keeping with the latest trends in architecture and interior design. Its modularity and the wide color range makes it suitable for any type of environment.

[FR] Il s'agit d'un système de panneaux modulaires pour sous-plafond qui unit à la fois absorption du son à la modernité et l'élégance, en harmonie avec les nouvelles tendances de l'architecture et l'interior design. Sa modularité et la large gamme de couleurs le rend approprié pour tout type d'environnement.

[SP] Uniko es un sistema modulares de paneles para encimeras que combina una alta absorción de sonido con un diseño moderno y elegante, en sintonia con la nueva arquitectura y las tendencias de diseño de interiores. Su modularidad y amplia gama de colores lo hacen adecuado para cualquier tipo de ambiente, mejorando el bienestar.

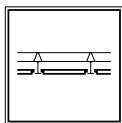

fissaggio a controsoffitto  
false ceiling installation



# Technical Specifications

## SIZES

UNIKO FLAT version

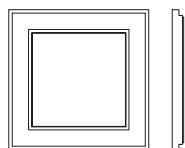

58,7x58,7x4,2 cm  
0,355m<sup>2</sup> - 1,1 kg

UNIKO PIRAMID version

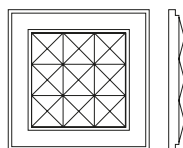

58,7x58,7x6,2 cm  
0,355m<sup>2</sup> - 1,1 kg

UNIKO 2 version

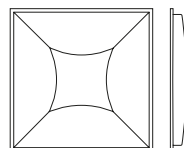

59,5x59,5x5 cm  
0,355m<sup>2</sup> - 0,6 kg

UNIKO 4 version

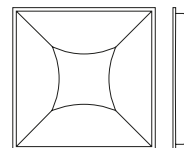

59,5x59,5x5 cm  
0,355m<sup>2</sup> - 0,6 kg



0,060 m<sup>3</sup> - 3,7 kg  
61x61x16 cm  
3pcs [carton]



0,060 m<sup>3</sup> - 3,7 kg  
61x61x16 cm  
3pcs [carton]



0,060 m<sup>3</sup> - 6,4 kg  
61x61x16 cm  
10pcs [carton]



0,060 m<sup>3</sup> - 6,4 kg  
61x61x16 cm  
10pcs [carton]

## FINISHING

Uniko (Flat/Piramid Version)



Felt 700



1012



1008



3082



4021



6052



7022

Uniko 2



Felt 700



Felt B



Felt N



Felt 032



Felt 065



Felt 086



Felt 806

Uniko 4



1010



1025



8014



8010



3090



4027



6071

[IT] I materiali di rivestimento adempiono alle più importanti normative antincendio internazionali.

[EN] Covering polyester materials follows fire retardant international standards.

[FR] Les revêtements en tissu répondent aux normes internationales.

[ES] Los materiales de recubrimiento cumplen con las más importantes regulaciones internacionales contra el fuego.

UNI 9174 - 8456 Class C1.  
DIN 4102 Class B1, NF 92501-7 Class M1.  
Class AM18, EN 1021-1 & 2, BS Crib 5, BS 7176  
Class Medium Hazard, IMO A 652 (16) Part 8 Upholstery

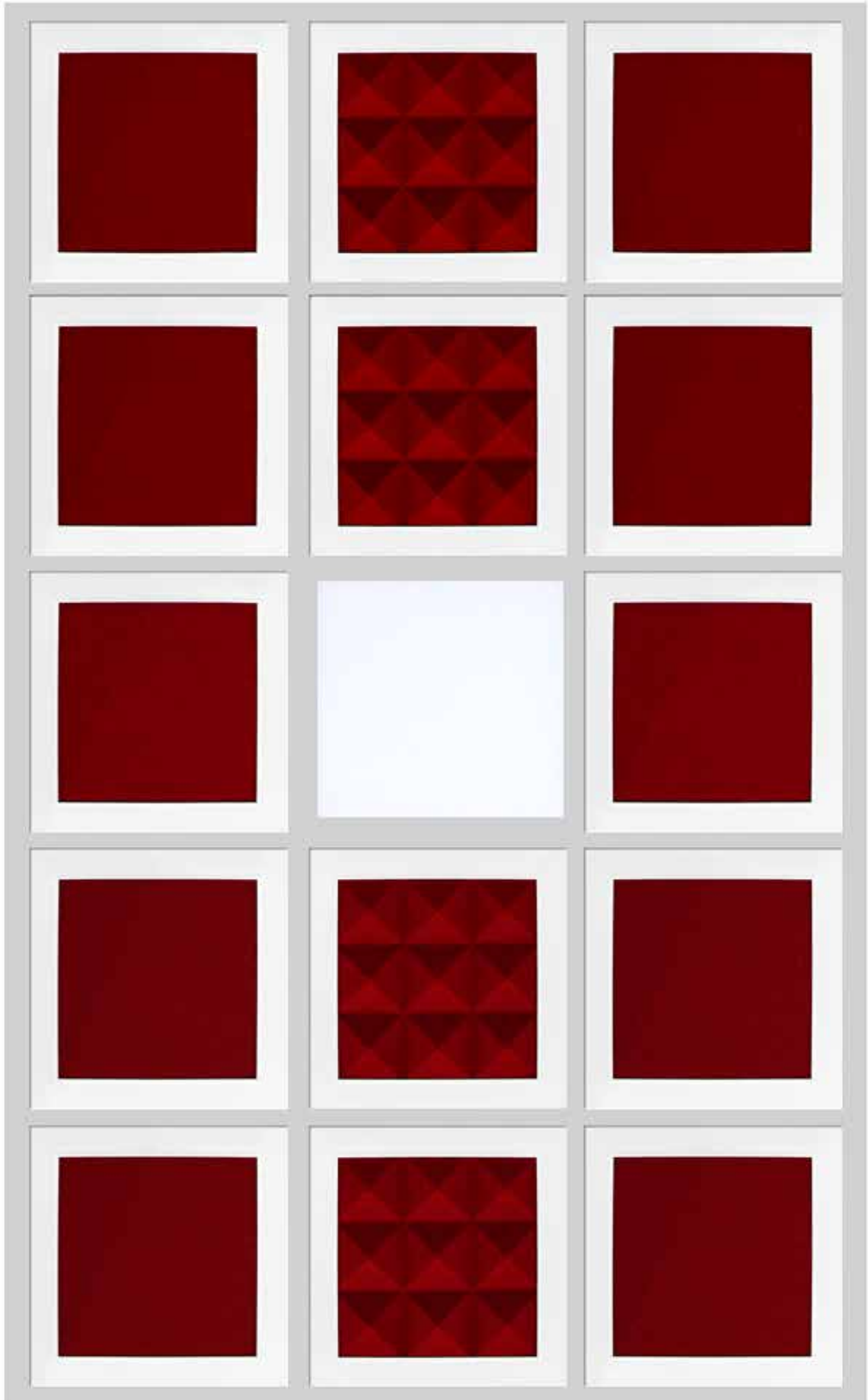

# Madison

Studio Eurolinea Design

[IT] L'elemento quadrato Madison, permette di creare varie **composizioni grafiche**; questa soluzione consente di intervenire a posteriori su superfici orizzontali, installando i pannelli alla griglia come controsoffitto, con una copertura totale dell'area disponibile.

[EN] The standard Madison square panel comes in different colors and finishes, making possible an infinite range of **graphic compositions**. These panels can be fitted to horizontal surfaces, by securing them to the grid and creating a false ceiling.

[FR] L'élément carré Madison, disponibles en différentes couleurs et finitions, vous permet de créer des **compositions graphiques** infinies. Cette solution permet d'intervenir sur des surfaces horizontales en adaptant les panneaux au cadre/grille comme sous-plafond avec une couverture totale de la surface disponible.

[SP] El elemento cuadrado Madison, le permite crear diferentes **composiciones gráficas**; esta solución permite de trabajar en superficies horizontales, aún existente, a través de la instalación como encimeras, con una cobertura total de área disponible.

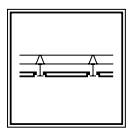

fissaggio a controsoffitto  
false ceiling installation

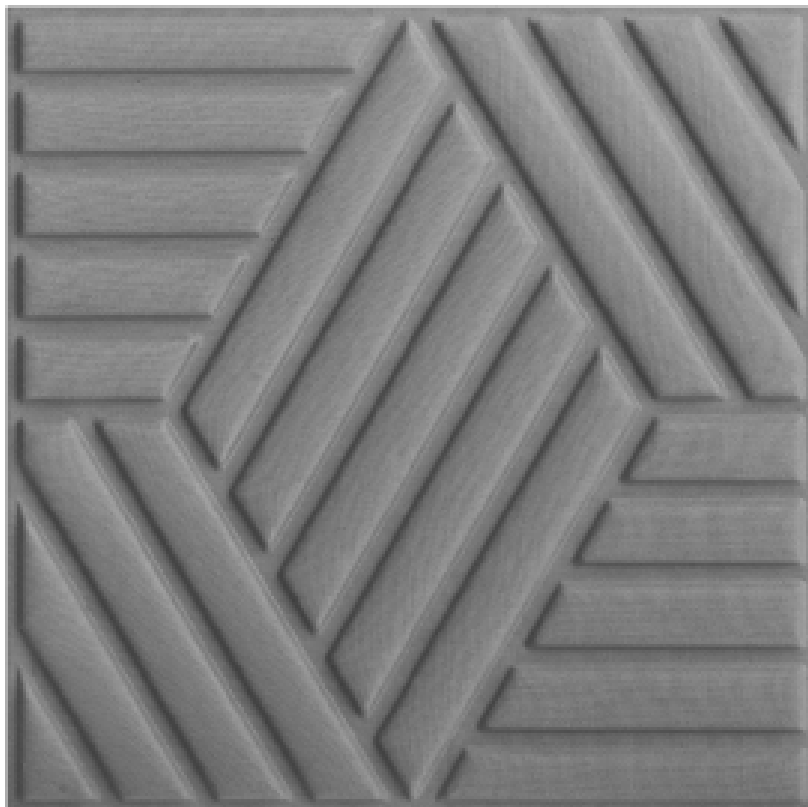





# Technical Specifications

## SIZES

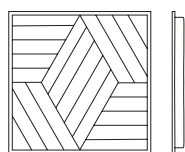

59.5x59.5x1.5 cm  
0.355m<sup>2</sup> - 0.65 kg



0.060 m<sup>3</sup> - 6.5 kg  
61x61x16 cm  
10pcs (carton)

## FINISHING

### Madison 2



Felt 700



Felt B



Felt N



Felt 032



Felt 065



Felt 086



Felt 806

### Madison 4



1010



1025



8014



8010



3090



4027



6071

[IT] I materiali di rivestimento adempiono alle più importanti normative antincendio internazionali.

[EN] Covering polyester materials follows fire retardant international standards.

[FR] Les revêtements en tissu répondent aux normes internationales.

[ES] Los materiales de recubrimiento cumplen con las más importantes regulaciones internacionales contra el fuego.

UNI 9174 - 8456 Class C1.  
DIN 4102 Class B1, NF 92501-7 Class M1,  
Class AM18, EN 1021-1 & 2, BS Crib 5, BS 7176  
Class Medium Hazard, IMO A 652 (16) Part 8 Upholstery







# Diamante

Studio Eurolinea Design

[IT] Il sistema Diamante è caratterizzato dalla modularità e dalle grandi dimensioni dei pannelli fonoassorbenti, che possono essere posizionati a parete, a soffitto, a sospensione, a piedistallo o attorno ad una scrivania. I pannelli Diamante garantiscono così, oltre ad un **considerevole miglioramento acustico**, una maggiore privacy sul posto di lavoro grazie alla separazione degli spazi.

[EN] The Diamante acoustic system is characterized by a modular design and a large size of the sound-absorbing panels: they can be located on walls, ceilings, floor screens or around desks. Diamante panels ensure an **acoustic improvement** and more privacy of the workplace, allowing a separation of spaces.

[FR] Le système acoustique Diamante se caractérise par sa polyvalence et les grandes dimensions de ses panneaux phono-absorbants, qui peuvent être placés au mur, au plafond, sur piédestal ou autour d'un bureau. Les panneaux Diamante **garantissent une amélioration acoustique** et plus d'intimité sur le poste de travail, en delimitant les espaces.

[SP] El sistema Diamante se caracteriza por el diseño modular y por el gran tamaño de los paneles fonoabsorbentes, que pueden colocarse en la pared, en el techo, pedestal o alrededor de los escritorios. Los paneles Diamante **garantizan una mejora acústica** y una mayor privacidad en el lugar de trabajo, permitiendo también una separación de los espacios.

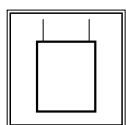

sospensione verticale  
vertical suspension

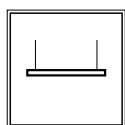

sospensione orizzontale  
horizontal suspension

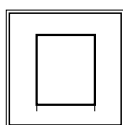

pedistallo  
pedestal

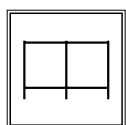

divisorio  
partition

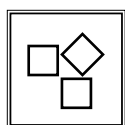

fissaggio a parete  
wall assembly



illuminazione opzionale  
lighting option



INNOVATIONSPREIS  
ARCHITEKTUR +  
OFFICE





# Technical Specifications

## SIZES

Diamante

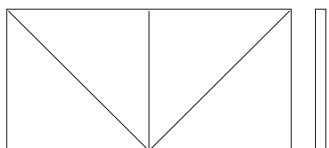

118,5x59x3,3 cm  
0,7m<sup>2</sup> - 2,7 kg

Diamante Double

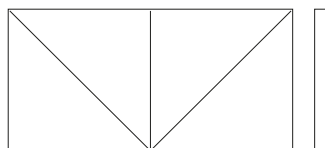

118,5x59x3,6 cm  
0,7m<sup>2</sup> - 3,54 kg

Diamante



0,11 m<sup>3</sup> - 12 kg  
123x62x16 cm  
4pcs (carton)

Diamante Double



0,12 m<sup>3</sup> - 15,7 kg  
123x62x16 cm  
4pcs (carton)

Diamante Spotlight X2

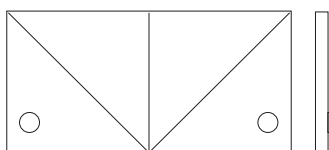

118,5x59x5,7 cm  
0,7m<sup>2</sup> - 3,6 kg

Diamante Spotlight X4

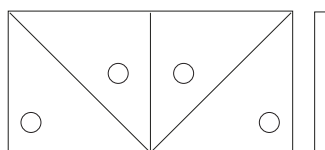

118,5x59x5,7 cm  
0,7m<sup>2</sup> - 3,7 kg

Diamante Spotlight X2



0,12 m<sup>3</sup> - 9 kg  
123x62x16 cm  
2pcs (carton)

Diamante Spotlight X4



0,12 m<sup>3</sup> - 9 kg  
123x62x16 cm  
2pcs (carton)

## ACCESSORIES

ACCV004

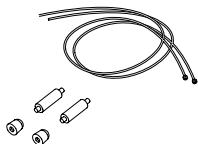

Sospensione Verticale  
Vertical Suspension

ACCV005

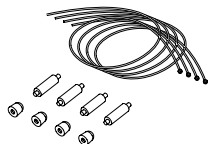

Sospensione Orizzontale  
Horizontal Suspension

ACCV006

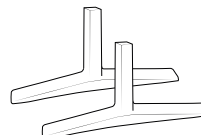

Piedistallo  
Pedestal

ACCV007

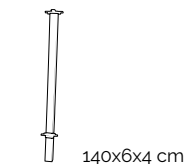

Divisorio  
Screen Partition

ACCV008

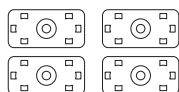

Fissaggio a parete  
Wall fixing

ACCV009

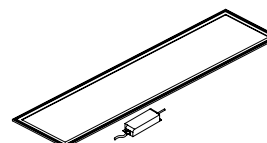

Sistema di illuminazione per sospensione orizzontale  
Horizontal Suspension Lighting System



### FINISHING

#### Diamante 2



#### Diamante 4



#### Frame

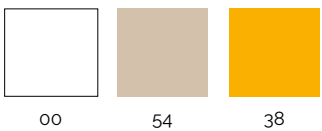

[IT] I materiali di rivestimento adempiono alle più importanti normative antincendio internazionali.  
 [EN] Covering polyester materials follows fire retardant international standards.  
 [FR] Les revêtements en tissu répondent aux normes internationales.  
 [ES] Los materiales de recubrimiento cumplen con las más importantes regulaciones internacionales contra el fuego.

UNI 9174 - 8456 Class C1.  
 DIN 4102 Class B1, NF 92501-7 Class M1,  
 Class AM18, EN 1021-1 & 2, BS Crib 5, BS 7176  
 Class Medium Hazard, IMO A 652 (16) Part 8 Upholstery

# Bespoke Landscapes

[IT] Diamante 4 e Diamante 4 Double sono personalizzabili per mezzo di stampa digitale. Le immagini fornite verranno stampate sui pannelli, offrendo quindi la possibilità di creare delle composizioni personalizzate e dalle alte performance di assorbimento acustico.

[EN] Diamante 4 and Diamante 4 Double are customizable through digital printing. The supplied images will be printed on the panels, thus offering the possibility to create customized compositions with high sound absorption performances.

[FR] Les panneaux acoustiques Diamante 4 et Diamante 4 Double peuvent être personnalisés grâce à l'impression numérique. Les images fournies seront imprimées sur les panneaux, offrant ainsi la possibilité de créer des compositions personnalisées aux performances d'absorption acoustique élevées.

[ES] Diamante 4 y Diamante 4 Double se pueden personalizar mediante impresión digital. Las imágenes suministradas se imprimirán en los paneles, ofreciendo así la posibilidad de crear composiciones personalizadas con un alto rendimiento de absorción de ruido.









# Pattern Examples

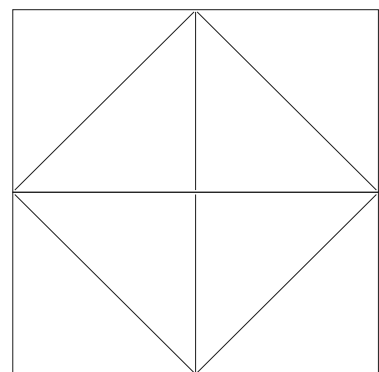
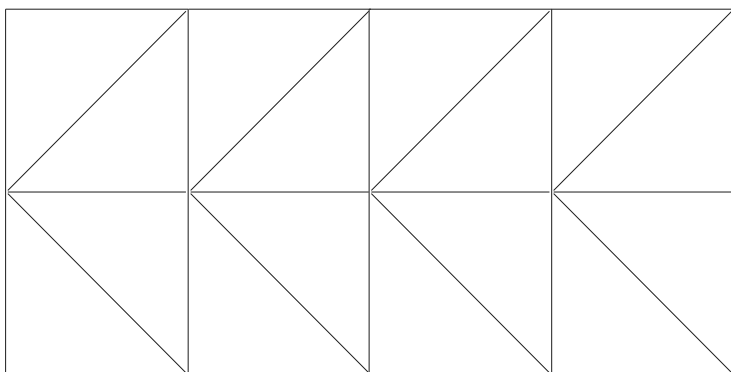
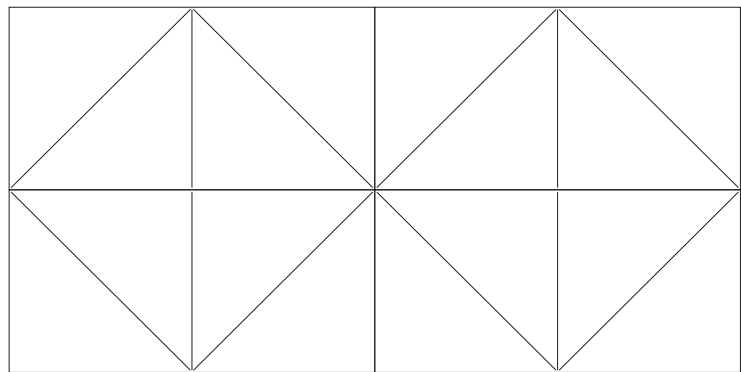
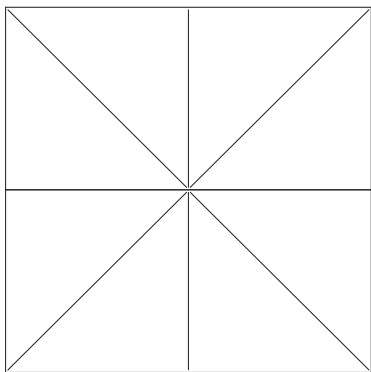
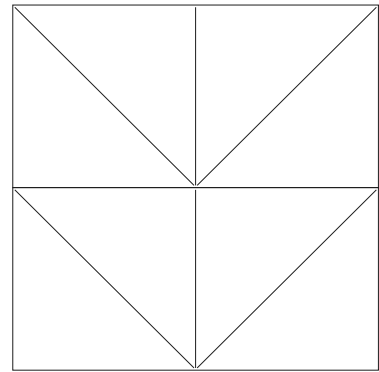
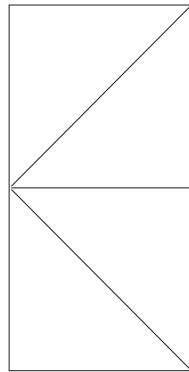
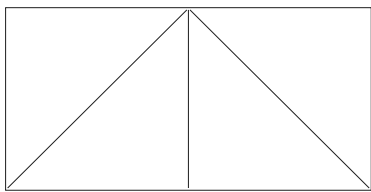









# Screen Pattern Examples

quote in mm

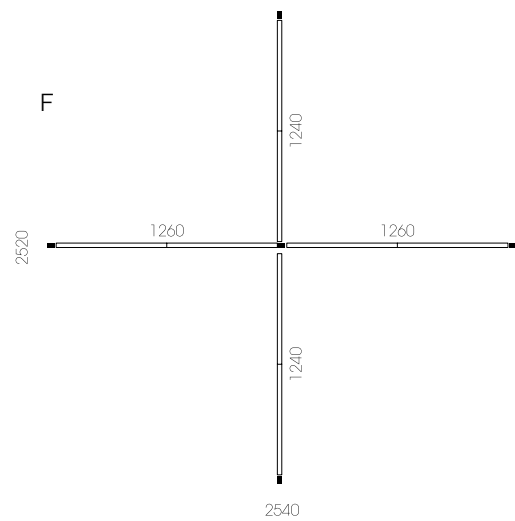
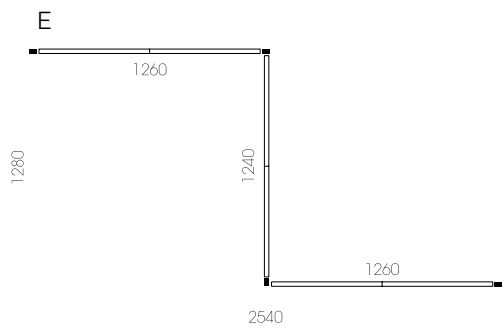
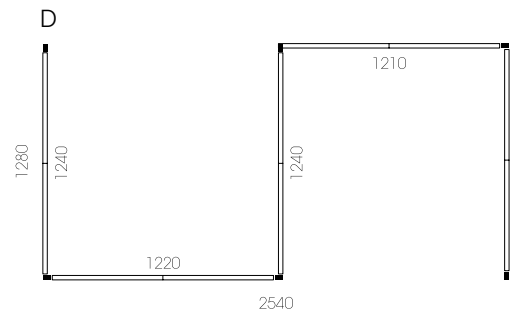
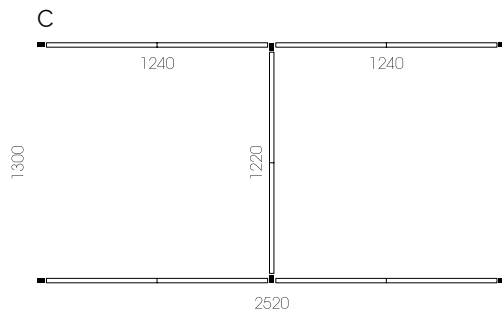
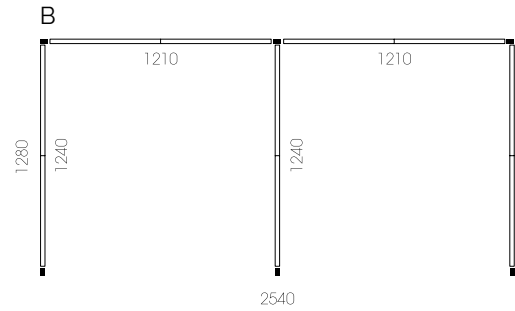
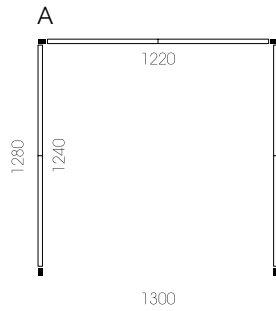

A2

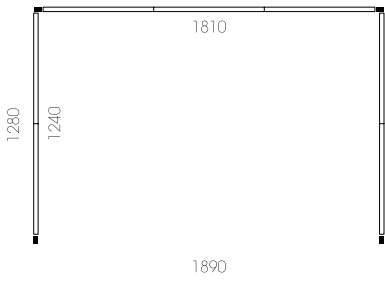

B2

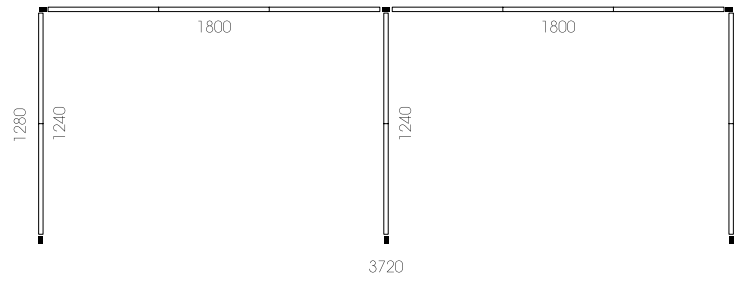

C2

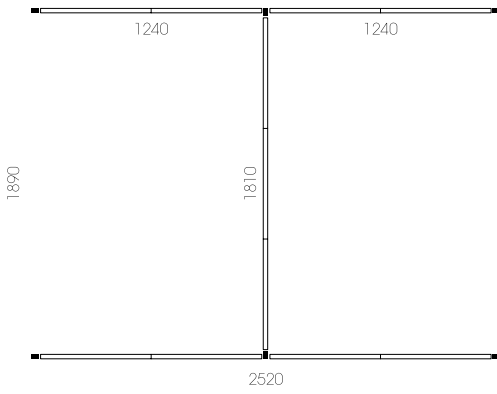

D2

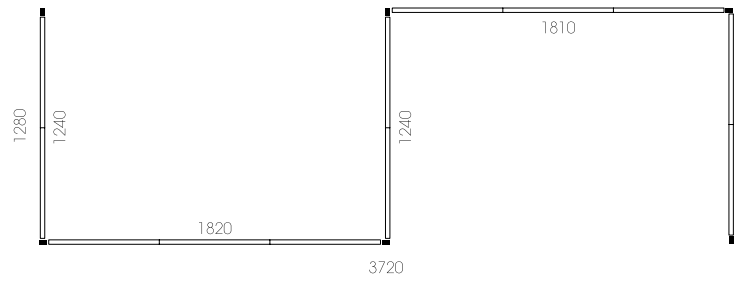







# Piuma

Studio Eurolinea Design

[IT] Il sistema di pannelli fonoassorbenti Piuma aiuta a migliorare l'acustica delle postazioni di lavoro, suddividendo tra loro i piani scrivania e creando una barriera visiva per ottimizzare la privacy. Grazie a speciali staffe in tecnopolimero, i pannelli Piuma possono essere fissati ai piani, anche di diversi spessori. La configurazione dei piani di lavoro può essere cambiata rapidamente.

[EN] The sound-absorbing Piuma panel system helps to improve the work-station acoustics, dividing up worktops and creating a privacy screen. Thanks to their specially developed technopolymer brackets, Piuma panels can be fixed to different thickness desktops with the result that the layout of work-tops can be switched around quickly.

[FR] La ligne de panneaux insonorisants Piuma contribue à améliorer l'acoustique sur les postes de travail, en divisant les bureaux entre eux, uniquement au niveau du plan de travail et en créant une barrière visuelle pour optimiser le privé. Grâce aux supports spéciaux en technopolymère, les panneaux Piuma peuvent être fixés directement sur les plateaux, de différentes épaisseurs. La configuration des plans de travail peut être modifiée rapidement et à tout moment.

[SP] El Sistema de paneles de absorción Piuma ayuda a mejorar la acústica de las estaciones de trabajo, dividiendo las encimeras entre ellas y creando una barrera visual para optimizar la privacy. Gracias a losportes especiales en tecno-polimero, los paneles Piuma pueden ser fijados en planos de diferente espesor; de esta manera es posible cambiar rápidamente la configuración de la mesa de trabajo.

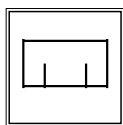

divisorio  
partition





# Technical Specifications

## SIZES

PIUMA 55



55x42x3,2 cm  
0,5 kg

PIUMA 65



65x42x3,2 cm  
0,6 kg

PIUMA 75

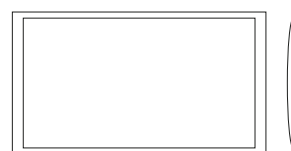

75x42x3,2 cm  
0,7 kg

PIUMA 150

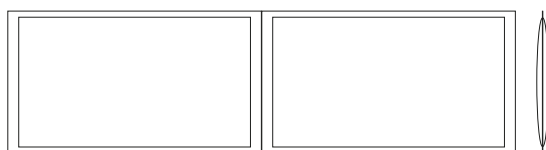

150x42x3,2 cm  
1,4 kg

## FINISHING



1012  
avorio/ivory

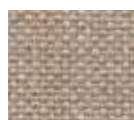

1008  
tortora/dove-grey



4021  
rosso/red

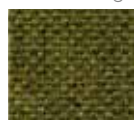

7022  
verde/green

[IT] I materiali di rivestimento adempiono alle più importanti normative antincendio internazionali.

[EN] Covering polyester materials follows fire retardant international standards.

[FR] Les revêtements en tissu répondent aux normes internationales.

[ES] Los materiales de recubrimiento cumplen con las más importantes regulaciones internacionales contra el fuego.

UNI 9174 - 8456 Class C1, UNI 9175 Class 1 IM,  
DIN 4102 Class B1, NF 92501-7 Class M1, NF D 60013  
Class AM18, EN 1021-1 & 2, BS Crib 5, BS 7176  
Class Medium Hazard, EN 13773 Class 1, OENORM  
3800-1 Class B1,Q1,TR1, California TB117, USA NFPA  
701, USA NFPA 260, IMO A 652 (16) Part 8 Upholstery







# Onda

Studio Eurolinea Design



## ACOUSTIC LAMP

[IT] Grazie alla sua forma sinuosa ed al materiale utilizzato, la lampada Onda cela dentro di sé la magia del silenzio. Onda riempie di carattere gli ambienti, decorandoli, illuminandoli e fungendo anche da elemento fonoassorbente.

[EN] Thanks to its curved shape and to the material utilized, the Onda lamp lies within itself the magic of silence. Onda fills of personality any environments, decorating and lighting them, even improving acoustic comfort.

[FR] Grâce à sa forme courbée et au matériau utilisé, la lampe Onda cache en elle-même la magie du silence. Onda remplit les environnements de caractère, en les décorant, en les éclairant et même agissant comme un élément absorbant acoustique.

[SP] Gracias a su forma curvada y el material utilizado, la lámpara Onda oculta en sí la magia del silencio. Onda llena entornos de carácter, con decoración y iluminación, mejorando el confort acústico.

# Technical Specifications

## SIZES

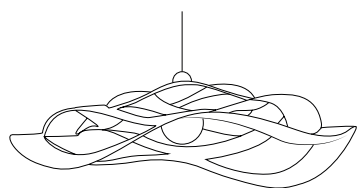

75Ø x 0,6cm  
0,7m<sup>2</sup> - 0,6 kg

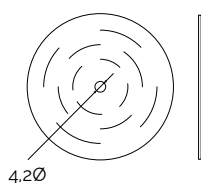

0,121m<sup>3</sup> - 2 kg  
78x78x2cm  
1pcs [carton]

## FINISHING



Felt B/700  
bianco/white  
grigio/grey



Felt B/032  
bianco/white  
rosso/red



Felt B/065  
bianco/white  
blu/blue

## ACCESSORIES

ACCV003

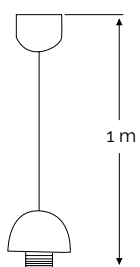

Portalampada Bianco  
White Lamp Holder

# Gaber®

Via Schiavonesca, 75/1  
31030 Caselle di Altivole (TV)  
Italy

Tel.: +39 0423 915521  
Fax: +39 0423 919417  
info@gaber.it  
gaber.it



acoustic  
design tool



All rights of reproduction in whole or in part of Gaber® literature, related to text, images or illustration, or transmitted by any means, electronic or mechanical, including photocopying, recording or any information storage without written permission from Gaber®, are reserved worldwide. For Customers' interest, the Company may modify its products without any prior notice. Gaber® reserves the right to suspend the production of any of its products without any notice or reason.





**Gaber**<sup>®</sup>  
gaber.it