

# Kumo

Design by Studio Stormo





① Struttura interna in legno sp. 50 mm rivestito in poliuretano espanso ad alta densità sp. 25 mm.

② Rivestimenti in tessuto.

③ Supporto lombare.

④ Modulo singolo in ABS (opzionale)  
1x presa elettrica Schuko + 2x USB Charger (Nero RAL 9011).

⑤ Piedino regolabile in PP Nero RAL 9005.

① Internal wood frame thk. 50 mm, high-density expanded polyurethane padding thk. 25 mm.

② Fabric covering.

③ Lower back support.

④ Single module in ABS (optional) 1x Schuko socket + 2x USB Charger (Black RAL 9011).

⑤ Adjustable black polypropylene (PP) plug.

① Structure intérieure en bois ép. 50 mm, revêtu de mousse de polyuréthane de haute densité.

② Revêtement en tissu.

③ Support lombaire.

④ Module unique en ABS (optionnel) 1x Schuko prise + 2x USB Charger (Noir RAL 9011).

⑤ Embout réglable en PP noir RAL 9005.

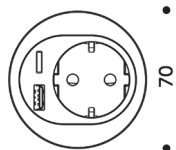

## BOX06 A01

Modulo singolo in ABS:  
1x presa elettrica  
Schuko + 2x USB  
Charger (Nero RAL  
9011).

## BOX06 A01

Single module in ABS:  
1x Schuko socket + 2x  
USB Charger (Black  
RAL 9011).

## BOX06 A01

Module unique en ABS:  
1x Schuko prise + 2x  
USB Charger (Noir RAL  
9011).

## POSIZIONAMENTO / POSITIONING / POSITIONNEMENT

### KUMO PB / KUMO PA

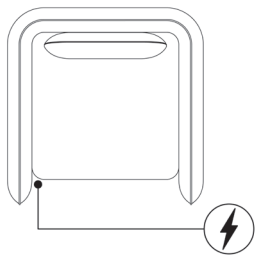

### KUMO DB / KUMO DA



## Finiture

Finishes / Finitions

### FINITURE TESSUTO

F1\* F2 F3 F4

### FABRIC FINISHES

### FINITION TISSU

\* Non disponibile: Planet

\* Not available: Planet

\* Non disponible: Planet

## Disegni Tecnici

Technical Drawings / Dessins Technique

### KUMO PB

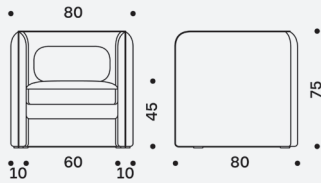

### KUMO PA

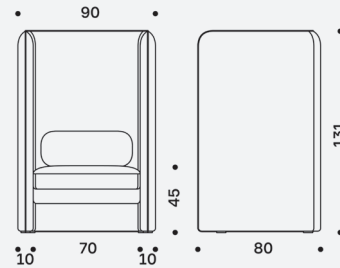

### KUMO DB

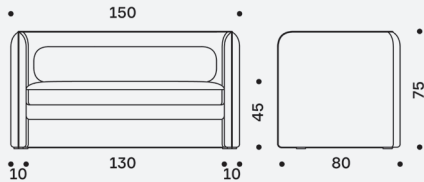

### KUMO DA

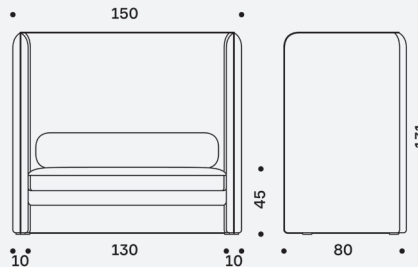

## Note

Notes / Note

### Garanzia

I nostri prodotti sono garantiti 5 anni (testo integrale della garanzia su richiesta). Un uso improprio del prodotto preclude la garanzia dello stesso.

### Warranty

Our products are guaranteed for 5 years (full text of the guarantee on request). Improper use of the product precludes its warranty.

### Garantie

Nos produits sont garantis 5 ans (texte complet de la garantie sur demande). Une mauvaise utilisation du produit exclut sa garantie.

### Uso improprio

Non sono consentiti: Modifiche strutturali e/o manomissioni al prodotto.

### Improper use

The following are not allowed: Structural changes and / or product tampering.

### Utilisation incorrecte

Les éléments suivants ne sont pas autorisés : Modifications structurelles et/ou altération du produit.

# Kumo POD

Design by Studio Stormo





1 Struttura interna in legno sp. 50 mm rivestito in poliuretano espanso ad alta densità sp. 25 mm.

2 Rivestimenti in tessuto.

3 Zip per unione divano/ pannello. Piastra di unione in acciaio nella parte inferiore.

4 Supporto fisso per monitor/ TV Nero (max 24") (Opzionale) Monitor non incluso.

5 Modulo multipresa in alluminio verniciato Nero RAL 9017 (Opzionale).

6 Tavolino con colonna decentrata.

1 Internal wood frame thk. 50 mm, high-density expanded polyurethane padding thk. 25 mm.

2 Fabric covering.

3 Zip for sofa/panel connection. Steel union plate at the bottom.

4 Black fixed support for monitor/TV (max 24") (Optional). Monitor not included.

5 Multi-socket module in painted aluminum Black RAL 9017 (Optional).

6 Table with decentralized column.

1 Structure intérieure en bois ép. 50 mm, revêtu de mousse de polyuréthane de haute densité.

2 Revêtement en tissu.

3 Zip pour jonction canapé/ panneau. Plaque d'union en acier dans la partie inférieure.

4 Support fixe pour moniteur/ TV Noir (max 24") (Optionnel). Moniteur non inclus.

5 Module multiprise en aluminium verni Noir RAL 9017 (Optionnel).

6 Table avec colonne décentralisée.

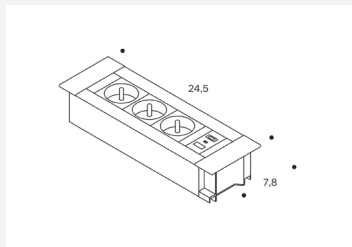

### BOX11

Modulo multipresa in alluminio verniciato Nero RAL 9017. Due composizioni disponibili.

3x Sockets + 1x Double USB charger (Type A+C)  
(Cod. **BOX11\_A**)

2x Sockets + 1x Double USB charger (Type A+C) + 1x USB Charger (Type C-60w)  
(Cod. **BOX11\_B**)

Prese elettriche



Multimedia



### BOX11

Multi-socket module in painted aluminum Black RAL 9017. Two compositions available.

Sockets

Multimedia

### BOX11

Module multiprise en aluminium verni Noir RAL 9017. Deux compositions disponibles.

Prises electriques

Multimedia

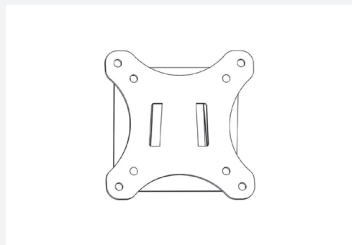

### ACC\_PA\_016

Supporto fisso per monitor/TV Nero (max 24").  
[VESA 75x75-100x100]

### ACC\_PA\_016

Black fixed support for monitor/TV (max 24").  
[VESA 75x75-100x100]

### ACC\_PA\_016

Support fixe pour moniteur/TV Noir (max 24").  
[VESA 75x75-100x100]

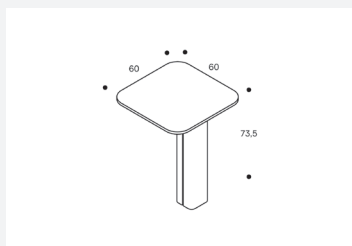

### ACC\_PA\_017/18

Tavolino con colonna decentrata in metallo verniciato Nero RAL 9005 e piano in MDF PerfectSense Graphite Grey U961 sp. 18 mm.

### ACC\_PA\_017/18

Table with decentralized column in Black RAL 9005 painted metal and MDF PerfectSense Graphite Grey U961 top thk. 18 mm.

### ACC\_PA\_017/18

Table avec colonne décentralisée en métal verni Noir RAL 9005 et plateau en MDF PerfectSense Graphite Grey U961 ép. 18 mm.

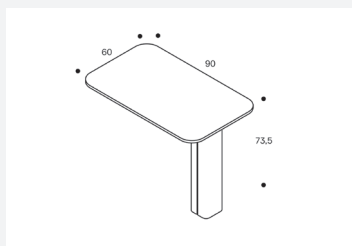

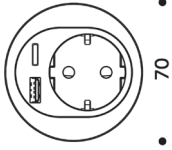

### BOX06 A01

Modulo singolo in ABS:  
1x presa elettrica  
Schuko + 2x USB  
Charger (Nero RAL  
9011).

### BOX06 A01

Single module in ABS:  
1x Schuko socket + 2x  
USB Charger (Black  
RAL 9011).

### BOX06 A01

Module unique en ABS:  
1x Schuko prise + 2x  
USB Charger (Noir RAL  
9011).

## POSIZIONAMENTO / POSITIONING / POSITIONNEMENT

### KUMO POD 1.1

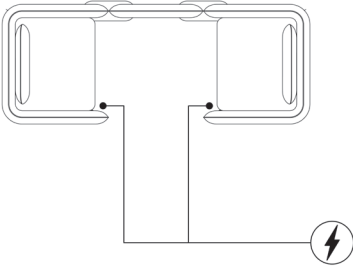

### KUMO POD 2.1

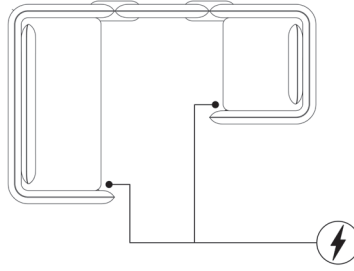

### KUMO POD 3.1

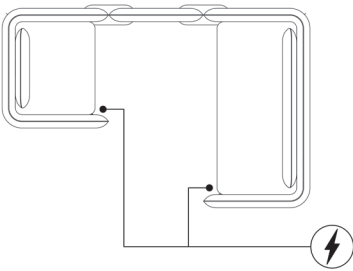

### KUMO POD 4.1

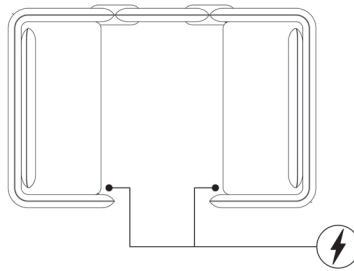



## Finiture

Finishes / Finitions

### FINITURE TESSUTO

F1\* F2 F3 F4

### FABRIC FINISHES

### FINITION TISSU

\* Non disponibile: Planet

\* Not available: Planet

\* Non disponibile: Planet

## Disegni Tecnici

Technical Drawings / Dessins Technique

### KUMO POD 1.1

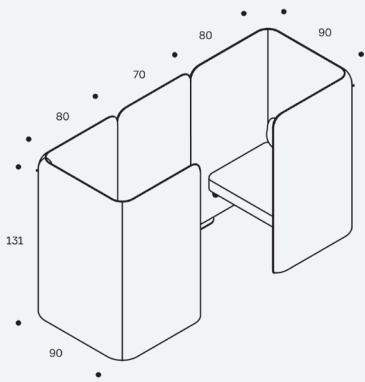

### KUMO POD 2.1

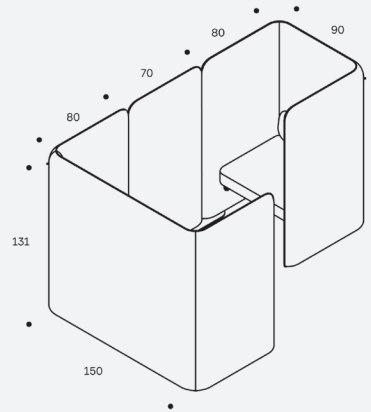

### KUMO POD 3.1

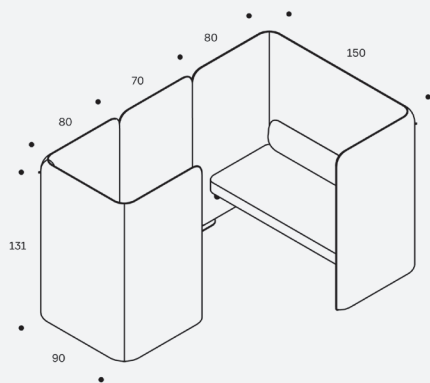

### KUMO POD 4.1

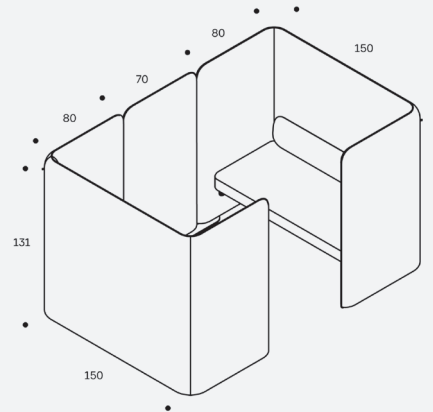

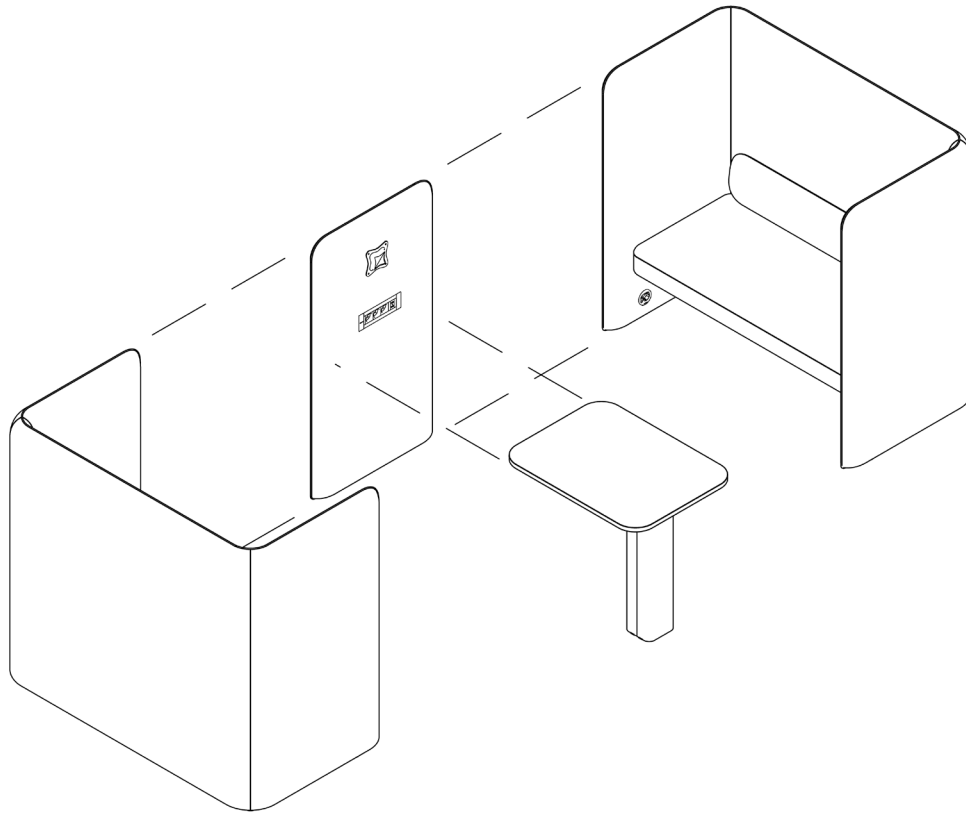

## Note

Notes / Note

### Pulizia

Per le parti metalliche consigliamo esclusivamente un panno morbido e alcool asciugando bene dopo la pulizia. Per le superfici in plastica, usare panno umido ed acqua con detersivo liquido neutro, non usare solventi, trielina, acetone o ammoniaca.

### Cleaning

For the metal parts we recommend only a soft cloth and alcohol, drying well after cleaning. For plastic surfaces, use a damp cloth and water with neutral liquid detergent, do not use solvents, trichlorethylene, acetone or ammonia.

### Nettoyage

Pour les parties métalliques, nous recommandons uniquement un chiffon doux et de l'alcool, bien sécher après le nettoyage. Pour les surfaces en plastique, utilisez un chiffon humide et de l'eau avec un détergent liquide neutre, n'utilisez pas de solvants, de trichloréthylène, d'acétone ou d'ammoniac.

### Garanzia

I nostri prodotti sono garantiti 5 anni (testo integrale della garanzia su richiesta). Un uso improprio del prodotto preclude la garanzia dello stesso.

### Warranty

Our products are guaranteed for 5 years (full text of the guarantee on request). Improper use of the product precludes its warranty.

### Garantie

Nos produits sont garantis 5 ans (texte complet de la garantie sur demande). Une mauvaise utilisation du produit exclut sa garantie.

### Uso improprio

Non sono consentiti: Modifiche strutturali e/o manomissioni al prodotto.

### Improper use

The following are not allowed: Structural changes and / or product tampering.

### Utilisation incorrecte

Les éléments suivants ne sont pas autorisés : Modifications structurelles et/ou altération du produit.

# Kumo Free Standing

Design by Studio Stormo





① Struttura interna in legno sp. 50 mm rivestito in poliuretano espanso ad alta densità sp. 25 mm ignifugo.

② Rivestimento in tessuto.

③ Piedino in acciaio Nero RAL 9005.

① Internal wood frame thk. 50 mm, high-density expanded polyurethane padding thk. 25 mm. Fire-retardant.

② Fabric covering.

③ Steel leg black Ral 9005.

① Structure intérieure en bois ép. 50 mm, revêtu de mousse de polyuréthane de haute densité. Ignifuge.

② Revêtement en tissu.

③ Pied en acier noir RAL 9005.

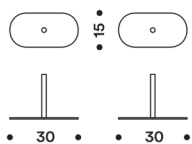

### KUMO 01

Set di piedini in acciaio nero RAL 9005 (2 pz.)

### KUMO 01

Set of steel legs black Ral 9005 (2 pcs.)

### KUMO 01

Jeu de pieds en acier noir RAL 9005 (2 pièces).

## Finiture

Finishes / Finitions

### FINITURE TESSUTO

### FABRIC FINISHES

### FINITION TISSU

F1\* F2 F3 F4

\* Non disponibile: Planet

\* Not available: Planet

\* Non disponible: Planet

## Disegni Tecnici

Technical Drawings / Dessins Technique

### KUMO FS 70X131

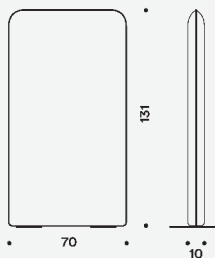

### KUMO FS 108X131

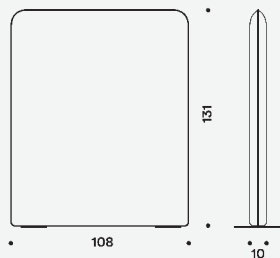

### KUMO FS 140X131

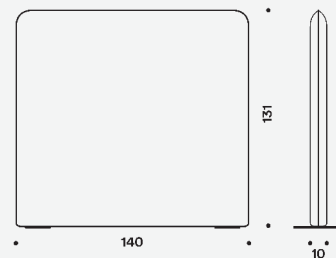

# Note

## Notes / Note

### Garanzia

I nostri prodotti sono garantiti 5 anni (testo integrale della garanzia su richiesta). Un uso improprio del prodotto preclude la garanzia dello stesso.

### Warranty

Our products are guaranteed for 5 years (full text of the guarantee on request). Improper use of the product precludes its warranty.

### Garantie

Nos produits sont garantis 5 ans (texte complet de la garantie sur demande). Une mauvaise utilisation du produit exclut sa garantie.

### Uso improprio

Non sono consentiti: Modifiche strutturali e/o manomissioni al prodotto.

### Improper use

The following are not allowed: Structural changes and / or product tampering.

### Utilisation incorrecte

Les éléments suivants ne sont pas autorisés : Modifications structurelles et/ou altération du produit.

# Kumo Cloud

Design by Studio Stormo



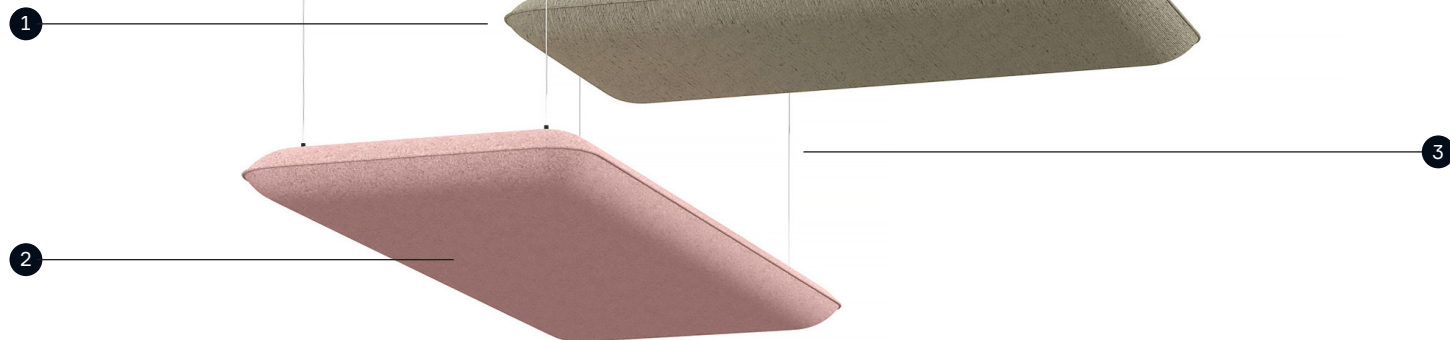

① Struttura interna in legno sp. 50 mm rivestito in poliuretano espanso ad alta densità sp. 25 mm.

② Rivestimento in tessuto.

③ Cavo d'acciaio fissaggio soffitto.

① Internal wood frame thk. 50 mm, high-density expanded polyurethane padding thk. 25 mm.

② Fabric covering.

③ Ceiling fixing steel cable.

① Structure intérieure en bois ép. 50 mm, revêtu de mousse de polyuréthane de haute densité.

② Revêtement en tissu.

③ Câble en acier fixation plafond.



# Finiture

Finishes / Finitions

## FINITURE TESSUTO

F1\* F2 F3 F4

## FABRIC FINISHES

## FINITION TISSU

\* Non disponibile: Planet

\* Not available: Planet

\* Non disponible: Planet

# Disegni Tecnici

Technical Drawings / Dessins Technique

KUMO CL 65X65

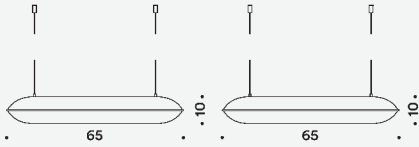

KUMO CL 120X65

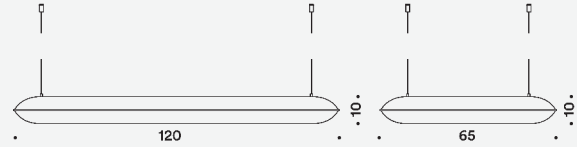

KUMO CL 160X65

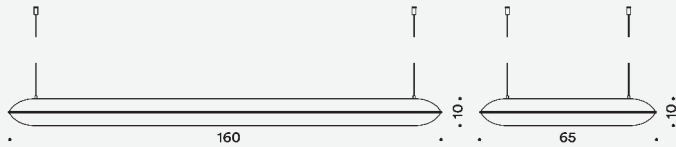

# Note

Notes / Note

## Garanzia

I nostri prodotti sono garantiti 5 anni (testo integrale della garanzia su richiesta). Un uso improprio del prodotto preclude la garanzia dello stesso.

## Warranty

Our products are guaranteed for 5 years (full text of the guarantee on request). Improper use of the product precludes its warranty.

## Garantie

Nos produits sont garantis 5 ans (texte complet de la garantie sur demande). Une mauvaise utilisation du produit exclut sa garantie.

## Uso improprio

Non sono consentiti: Modifiche strutturali e/o manomissioni al prodotto.

## Improper use

The following are not allowed: Structural changes and / or product tampering.

## Utilisation incorrecte

Les éléments suivants ne sont pas autorisés : Modifications structurelles et/ou altération du produit.

# Kumo Tav

Design by Studio Stormo

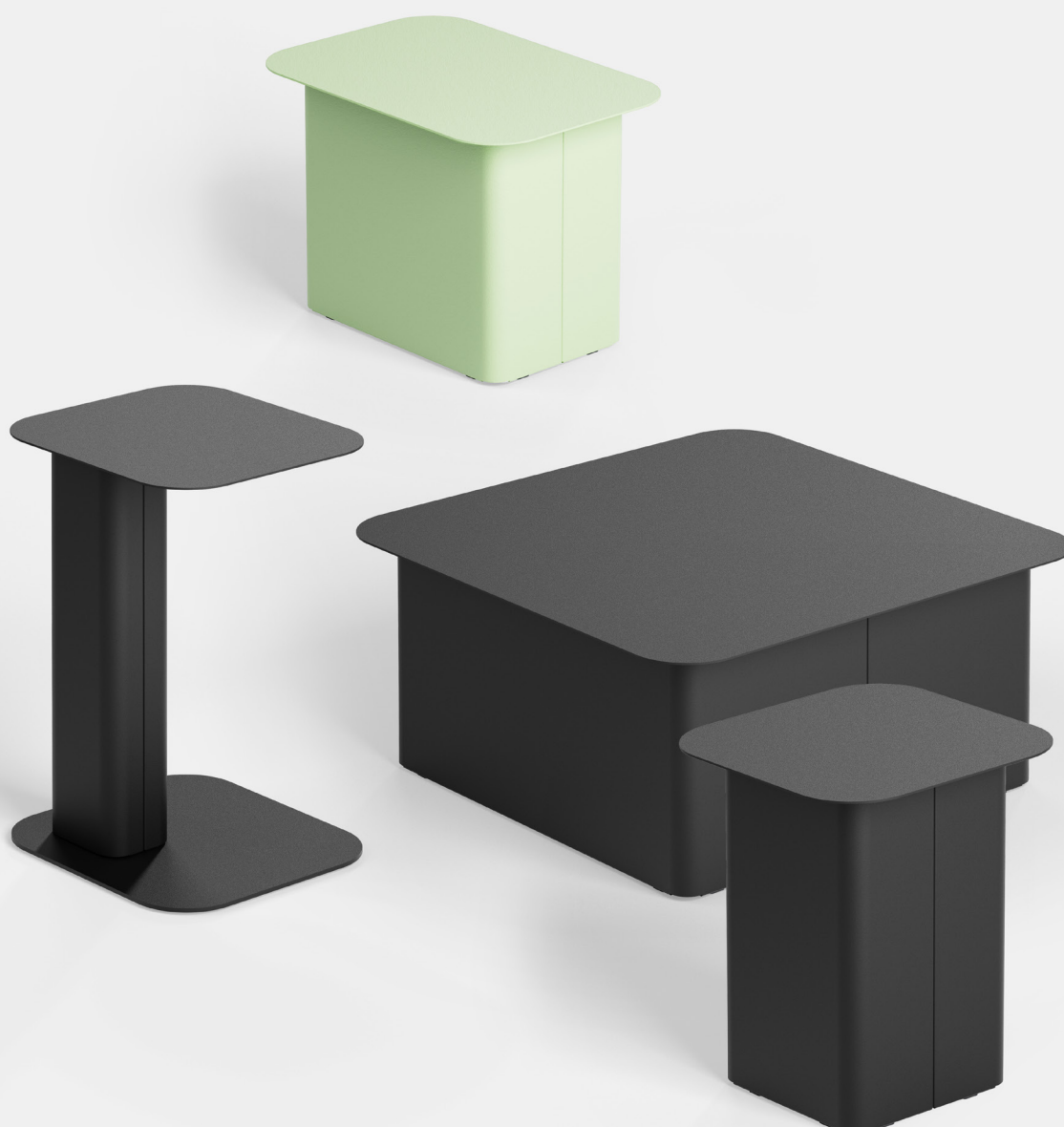

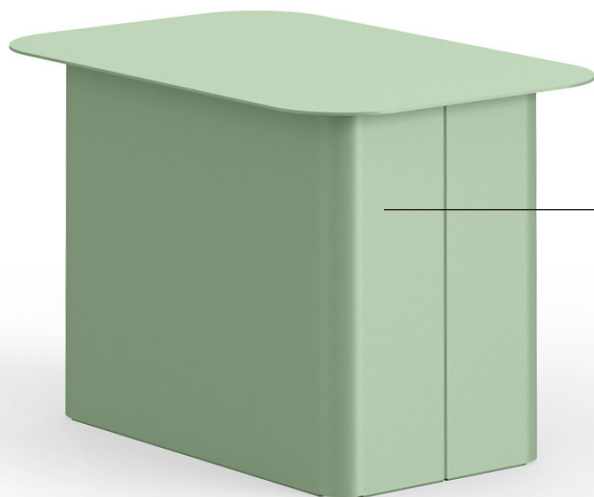

① Struttura in lamiera d'acciaio  
sp. 2,5 mm.

① Structure in 2.5 mm  
thick steel.

① Structure en Acier de 2,5 mm  
d'épaisseur.

## Finiture

Finishes / Finitions

### FINITURE STRUTTURA

Verniciato / Painted / Verni

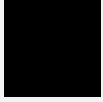

**RAL 9005**  
Nero  
Black  
Noir

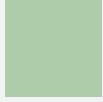

**RAL 6019**  
Verde Menta  
Mint Green  
Menthe Verte



**RAL 3004**  
Rosso  
Red  
Rouge

### FRAME FINISHES

### FINITIONS STRUCTURE

## Disegni Tecnici

Technical Drawings / Dessins Technique

### KUMO TAV S

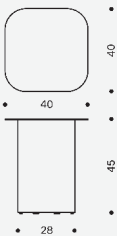

### KUMO TAV M

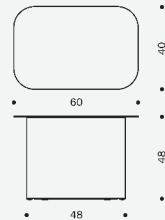

### KUMO TAV L

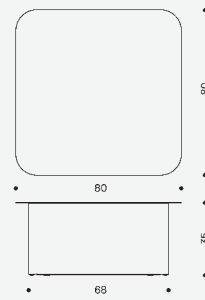

### KUMO TAV W\*

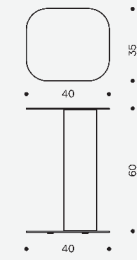

\*  
Disponibile versione con presa USB Charger (Type A/C) integrata nella colonna.  
Available with USB Charger (Type A/C) socket integrated into the column.  
Disponibile avec prise USB Charger (Type A/C) intégrée à la colonne.  
Erhältlich mit in die Säule integrierter USB-Ladebuchse (Typ A/C).

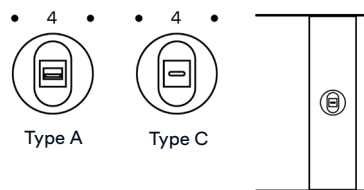

# Note

## Notes / Note

### Pulizia

Per le parti metalliche consigliamo esclusivamente un panno morbido e alcool asciugando bene dopo la pulizia. Per le superfici in plastica, usare panno umido ed acqua con detersivo liquido neutro, non usare solventi, trielina, acetone o ammoniaca.

### Cleaning

For the metal parts we recommend only a soft cloth and alcohol, drying well after cleaning. For plastic surfaces, use a damp cloth and water with neutral liquid detergent, do not use solvents, trichlorethylene, acetone or ammonia.

### Nettoyage

Pour les parties métalliques, nous recommandons uniquement un chiffon doux et de l'alcool, bien sécher après le nettoyage. Pour les surfaces en plastique, utilisez un chiffon humide et de l'eau avec un détergent liquide neutre, n'utilisez pas de solvants, de trichloréthylène, d'acétone ou d'ammoniac.

### Garanzia

I nostri prodotti sono garantiti 5 anni (testo integrale della garanzia su richiesta). Un uso improprio del prodotto preclude la garanzia dello stesso.

### Warranty

Our products are guaranteed for 5 years (full text of the guarantee on request). Improper use of the product precludes its warranty.

### Garantie

Nos produits sont garantis 5 ans (texte complet de la garantie sur demande). Une mauvaise utilisation du produit exclut sa garantie.

### Uso improprio

Non sono consentiti: Modifiche strutturali e/o manomissioni al prodotto.

### Improper use

The following are not allowed: Structural changes and / or product tampering.

### Utilisation incorrecte

Les éléments suivants ne sont pas autorisés : Modifications structurelles et/ou altération du produit.